

# AGRO Ex cable glands.

Professional cable glands for potentially explosive atmospheres.





# Explosion protection.

## Necessary more frequently than you might think.

In the 19th century, electrical technology made its way into both industry and the home. Immediately thereafter, the first fundamentals for protection against electrical explosions were developed because of the methane gas and coal dust which arose during the mining of anthracite coal. The advantages of electricity were so overwhelming that people started working intensively to come up with ways to prevent any possible meeting of explosive atmospheres and ignition sources – resulting from the use of electrical equipment – and in this way could avoid explosions.

This application in mining was just the start. The chemical and petrochemical industries as well as oil and gas extraction represent more application areas where explosion-proof equipment is needed. Additionally, organic chemistry, the paint and varnish industry as well as the pharmaceuticals industry all process and work with flammable liquids and gases. And today even more application areas are constantly emerging, for instance with the extraction and use of biogas or the ecological use of disposal sites and landfills. In the processing of wood and grain there are yet more potential sources of danger. The use of hydrogen is being discussed intensively, and here, too, this will lead to various applications requiring explosion protection.

Anyone who is involved professionally with industrial systems must now be very conscious about the topic of explosion protection. In many industries, gases, vapours or mists build up or escape during the manufacture, processing, transport or storage of combustible materials, and these are released into the environment. Combustible dust is created in other processes. When these are combined with oxygen in the air, a hazardous atmosphere can build up which if ignited results in an explosion.

Explosion protection is governed by the legislation of individual countries around the world. Differences in technical requirements specific to each country and the required permits for explosion-proof equipment place high requirements on manufacturers, especially those with global operations, and these result in high costs for product development and approvals processes. In the wake of globalisation, though, it has been possible to make great strides towards uniform policies for explosion protection.

In Europe, since 1 July 2003 only equipment, components and protective systems intended for use in potentially explosive atmospheres can be placed on the market if they meet the requirements of the ATEX 94/9/EC equipment directive, whose goal is preventing serious damage to persons and installations.





Sugar dust explosion at Port Wentworth

	Directives and regulations		4 - 5
	General information about explosion protection		6 - 7
<b>Flameproof enclosure Ex d IIC</b>	If there is any ignition inside the enclosure, it withstands the pressure – the explosion does not spread outside the unit.	<b>Series 18</b> <b>Ex Compact MS</b>	<b>8 - 9</b> <b>10 - 11</b>
<b>Increased safety Ex e II</b>	The equipment or its components prevent the ignition of an explosive atmosphere within the enclosure.	<b>Ex Compact MS</b> <b>Progress® MS EX</b> <b>Progress® MS Multi EX</b> <b>Progress® MS KB EX</b> <b>Progress® MS T + KB</b> <b>Progress® MS EMV Rapid EX</b> <b>Progress® MS EMV EX</b> <b>Progress® MS EMV KB EX</b> <b>Progress® MS Kombi EX</b> <b>Progress® GFK EX</b> <b>Progress® GFK Multi EX</b>	<b>11</b> <b>12 - 14</b> <b>15</b> <b>16 - 17</b> <b>18</b> <b>19</b> <b>20</b> <b>21</b> <b>22 - 23</b> <b>24 - 26</b> <b>27 - 28</b>
<b>Intrinsic safety Ex i II</b>	Limiting the energy in electrical circuits prevents the development of excessively high temperatures, sparks or electric arcs.	<b>Progress® GFK EX</b>	<b>29 - 30</b>
	Accessories, certificates		<b>31</b>



# Directives and regulations

## **ATEX 95 (Directive 94/9 EC)**

With ATEX product directive 94/9/EG (ATEX 95) and ATEX operating directive 1999/92/EG (ATEX 137), the European Union laid the foundation for harmonised European explosion protection. This safety concept applies to both the manufacture of electrical and non-electrical equipment and the operation of such units in the affected industrial systems.

The legislatures of the individual member states implement these directives with corresponding laws.

## **IECEx**

The international IECEx scheme likewise serves for the conformity assessment and certification of equipment, systems and services for use in potentially explosive atmospheres.

Introduced in 1996, the IECEx system supports the international harmonisation of standards and the issue of country- and region-neutral certificates of conformity (CoC) to simplify the free movement of goods around the world. There is already an extensive agreement between the European ATEX directives and the IECEx regulations as regards classes and requirements. This all means that ATEX could one day be replaced.

**In those countries which recognise IECEx, certified equipment, apparatus and systems can be put into service without additional tests.**

**Today, IECEx is recognised not only in Europe but in many additional countries including Australia, New Zealand, Brazil, Canada, China, Japan, Korea, Malaysia, Singapore, South Africa, USA...**

**You can find further information about the IECEx system and its rules as well as regulations, handbooks and procedures at [www.iecex.com](http://www.iecex.com).**

**“Equipment”** refers to machines, apparatus, fixed or mobile devices, control components and instrumentation thereof and detection or prevention systems which, separately or jointly, are intended for the generation, transfer, storage, measurement, control and conversion of energy for the processing of materials and which are capable of causing an explosion through their own potential sources of ignition.

**“Components”** refers to any item essential for the safe functioning of equipment and protective systems but with no autonomous function.

An **“explosive atmosphere”** is a mixture with air, under atmospheric conditions, of flammable substances in the form of gases, vapours, mists or dusts in which, after ignition has occurred, combustion spreads to the entire unburned mixture.

A **“potentially explosive atmosphere”** is one which could become explosive due to local and operational conditions.

The manufacturer must take great care to provide sufficient information and instructions necessary for the proper operation and maintenance of equipment.





### Prerequisites for certification

With an Annex, ATEX95 defines various modules for the commercialisation of equipment intended for use in potentially explosive atmospheres. Modules III and IV are often used and applied at AGRO as well, and from them two certificates result:

- **EC type-examination certificate**
- **QS approval**

Both certificates are issued by accredited testing facilities after tests have been successfully completed.

#### EC type-examination certificate

The EC type-examination certificate is the document which is issued based on successful technical testing.

#### QS approval

A requirement of ATEX95 is production which has been tested and is monitored. It ensures that products placed on the market are identical with the test samples used for the EC type-examination certificate. For companies which have a certified QM system conforming to ISO 9001:2000, an additional Ex audit is not necessary. Repeat audits follow at regular intervals.

#### CE declaration of conformity

The CE declaration of conformity is based on the EC type-examination certificate and QS approval. With it, a manufacturer declares that it has observed all applicable standards, instructions and regulations. This is made visible with the CE symbol, which is a part of the marking.

### Standards

Numerous standards which address explosion protection exist around the world. The scope of standards is, however, subject to continuous updates which reflect technical advances and increased societal requirements regarding safety. International harmonisation efforts around the world have as their goal globally unified safety standards to help break down trade barriers.

Equipment is differentiated by the corresponding series of standards:

IEC/EN 60079	for electrical equipment (gases, vapours and dust)
EN 13463	for non-electrical equipment (will in future be replaced by EN 80079)

Which type of ignition protection a manufacturer selects depends on the type and intended function of the equipment. All standardised types of ignition protection within a given category are equivalent. A manufacturer confirms with the EC type-examination certificate, which belongs to the technical documentation, that its product conforms to ATEX directives.

### Certification

Equipment intended for use in potentially explosive atmospheres may only be brought to market if they have undergone the conformity assessment procedures dictated in the directives. For equipment, certification must be conducted by a designated testing facility. EC type-examination certifications from a designated European testing facility are recognised within the entire EU.

## Conditions for an explosion

As a rule, an explosion can only take place in atmospheric air if three factors come together:

- a flammable material
- oxygen (in the air)
- ignition source

The first two factors – flammable material and air – must be present in a corresponding concentration so that they can form an explosive atmosphere.

Descriptions of explosion protection are thus in general limited to the depiction of reactions with oxygen in air. Oxidation reactions which are generally associated with the generation of heat and pressure fulfil the criteria for an explosion.

Hazardous areas for explosions can develop in manufacturing facilities and workplaces. Typical hazardous areas arise in chemical factories, refineries, paint factories, paint shops, cleaning systems, mills/warehouses for milled products, commercial bakeries and other places with combustible dusts, in tank farms and loading facilities for combustible gases, liquids and solids.

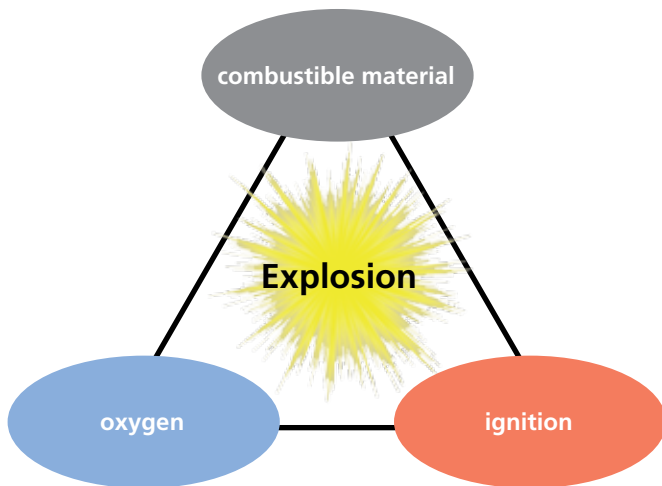

## What protective measures can be taken to reduce the danger of explosion?

- avoid combustible substances
- inerting (addition of nitrogen, carbon dioxide, etc.)
- limiting concentration levels
- improved ventilation
- secondary explosion protection is necessary if the danger of explosion cannot be ruled out through primary explosion protection measures

### Equipment marking

The following can be identified from the marking of electrical equipment for hazardous areas:

- equipment manufacturer
- a designation from which it can be identified
- the area of use:
  - underground I
  - other areas II
- the categories which indicate if the device can be used in certain areas
- the type(s) of ignition protection which the equipment fulfils
- the overall identification of the certificate

**M** – this prefix stands for underground mines

**G** – this suffix stands for combustible gases, mists or vapours

**D** – this suffix stands for dust

Numerals express the degree.

- Equipment category 1** very high degree of safety
- Equipment category 2** high degree of safety
- Equipment category 3** normal degree of safety

- Equipment protection level a** very high degree of protection and thus a very high degree of safety
- Equipment protection level b** high degree of protection and thus a high degree of safety
- Equipment protection level c** normal degree of protection and thus an increased level of safety

This results in the assignment of the equipment categories to the zones.

## Examples for zone assignment in the Ex area

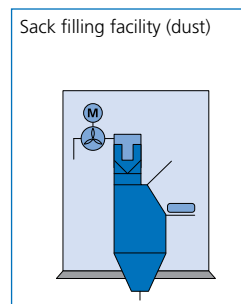
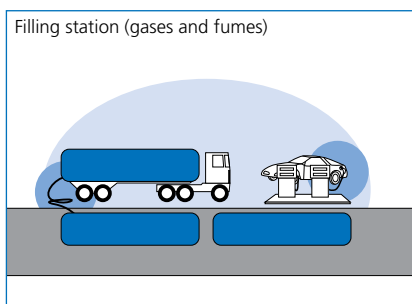

	Zone assignment					
	Gas			Dust		
	Zone 0	Zone 1	Zone 2	Zone 20	Zone 21	Zone 22
Frequency of explosion hazard	continually or long-term	occasionally	seldom and short-term	same as Zone 0 Dust deposits alone do not make up Zone 20	same as Zone 1	same as Zone 2 or if accumulations of dust are present
Frequency of ignition sources from electrical equipment	never (even not during seldom operating malfunctions)	very seldom (even not if frequent operating malfunctions can be expected)	gelegentlich (z.B. bei Betriebsstörung)	same as Zone 0	same as Zone 1	same as Zone 2

Equipment assignment by zone			
Area	Level of the danger of explosion	Required marking on equipment to be used	
		Equipment group*	Category
Group II	Zone 0	II	1 G
Group II	Zone 1	II	2 G or / 1 G
Group II	Zone 2	II	3 G or / 2 G
Group II	Zone 20	II	1 D
Group II	Zone 21	II	2 D or / 1 D
Group II	Zone 22	II	3 D or as in / 2 D

\* Equipment is divided into two groups. Group 1 applies to equipment for use in mining and subject to firedamp environments and will not be further discussed here.



**For Group II equipment** a further subdivision is made into explosion groups and temperature classes.

Assignment in temperature classes		
Temperature class	Ignition temperature	Max. surface temperature of the equipment
T1	$\geq 450$ °C	450 °C
T2	300-450 °C	300 °C
T3	200-300 °C	200 °C
T4	135-200 °C	135 °C
T5	100-135 °C	100 °C
T6	85-100 °C	85 °C



## Explosion groups

Within the explosion groups, for electrical equipment a first distinction is made between Equipment Group I and Equipment Group II. Electrical equipment in Equipment Group I is used for mines susceptible to firedamp.

For electrical equipment in Equipment Group II, a further subdivision is made into explosion groups. The subdivision depends on the

maximum experimental safe gap (MESG) and the minimum ignition current. Electrical equipment with approval for Explosion Group IIC may also be used in Explosion Groups IIA and IIB. Electrical equipment in Equipment Group III is likewise subdivided into further explosion groups.

Explosion groups				
Equipment group	Application examples	Gas/dust group	Explosion group	MESG with flameproof enclosure
<b>Group I</b>	Electrical equipment for mines susceptible to firedamp → Firedamp protection Ex ...I			
<b>Group II</b>	Electrical equipment for areas which are hazardous due to explosive gases → Explosion protection Ex...II	IIA (e.g. propane)	IIA	> 0.9 mm
		IIB (e.g. ethylene)	IIB	0.5 bis 0.9 mm
		IIC (e.g. hydrogen)	IIC	< 0.5 mm
<b>Group III</b>	Electrical equipment for areas which are hazardous due to explosive dust → Explosion protection Ex ...III	IIIA (e.g. combustible flakes)	IIIA	
		IIIB (e.g. non-conductive dust)	IIIB	
		IIIC (e.g. conductive dust)	IIIC	



## Flameproof enclosures Ex d IIC and increased safety Ex e II

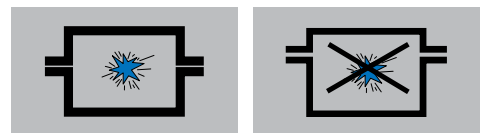

### Principle

With ignition protection type Ex d IIC, components which can ignite an explosive atmosphere are arranged in a housing. This housing must contain the pressure of the explosion and an explosive mixture within itself, and it must prevent the explosion from spreading to the explosive atmosphere surrounding the housing.

### Important design parameters

- The mechanical stability must correspond to that of a predetermined safety factor against internal explosion pressures.
- Gaps between two parts of a housing must be designed sufficiently long and narrow that exiting hot gas cannot ignite an explosive atmosphere which might be present in the hazardous area.
- The parameters for the gaps preventing an arc-through, width/length, are different for Explosion Subgroups IIA, IIB and IIC. The highest requirements on gap parameters are placed on the housings of Explosion Subgroup IIC.

### Applications

- Equipment which during normal operation can generate sparks or electric arcs and/or hot components; this includes switchgear and circuit breakers, controls, motors, transformers, slip rings, collectors, regulating resistors, fuses, lighting fixtures, heating cartridges and friction brakes.

Cable glands for flameproof enclosures are tested according to IEC/EN 60079-1 for the following points:

- mechanical design and pressure testing
- electrical and thermal behaviour

### 1 Entry threads

Long entry threads in metric, Pg, gas pipe or NPT designs provide maximum safety with respect to the quality of attachment.

### 2 Spanner surfaces

Large, solid spanner surfaces on the pressure nut and bottom section allow safe tightening with the assembly tool.

### 3 Guaranteed sealing capability

The ingenious sealing insert and matching inner contours ensure a targeted deformation of the insert and thus guarantee its tightness. Protection Class IP68 (30 bar) facilitate optimal usage.

### Testing standards

EC 60079-0:2011 / EN 60079-0:2009  
IEC 60079-1:2007 / EN 60079-1:2007  
IEC 60079-31:2008 / EN 60079-31:2009

### Marking

II 2G Ex db eb IIC  
II 2D Ex ta IIIC  
Equipment protection Level Gb Da  
PTB 00 ATEX 1059  
IEEx PTB 12.0056



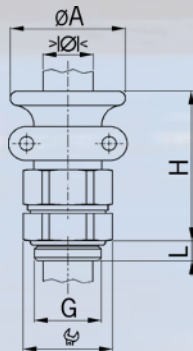

**Designation:** Series 18  
**Material:** Nickel-plated brass  
**Screws:** Stainless steel A2  
**Seal:** NBR  
 one-piece sealing insert, not overall length insulated  
**Temperature range:** -40°C / +100°C  
**Protection class:** IP 68 (30 bar)  
**Test standard:** see page 8  
**Category 2G:** II 2G Ex db eb IIC  
**Category 2D:** II 2D Ex ta IIC  
**Zone:** Gas 1 and 2 / dust 21 and 22  
**Certificate:** EC-type examination certificate PTB 00 ATEX 1059  
**IECEx Certificate:** IECEx PTB 12.0056  
**Approvals:**

**Entry thread metric**

G	>Ø< min mm	>Ø< max mm	 mm	ØA mm	H mm	L mm	Art.-Nr.	
M16x1.5	7.0	9.0	20	27	57	12	1817.09.26	25
M20x1.5	9.0	11.0	24	30	57	12	1820.11.26	25
M20x1.5	11.0	13.0	26	32	57	14	1820.16.26	25
M25x1.5	13.0	16.5	32	40	67	16	1825.21.26	10
M25x1.5	16.5	20.0	36	44	67	16	1825.21.27	10
M32x1.5	20.0	24.0	46	48	78	17	1832.29.26	5
M40x1.5	24.0	28.0	46	52	78	17	1840.29.27	5
M50x1.5	28.0	32.0	55	60	85	17	1850.36.26	5
M50x1.5	32.0	36.0	55	64	85	17	1850.36.27	5
M63x1.5	36.0	40.0	70	75	88	20	1863.48.26	1
M63x1.5	40.0	44.0	70	80	88	20	1863.48.27	1

**Entry thread Pg**

G	>Ø< min mm	>Ø< max mm	 mm	ØA mm	H mm	L mm	Art.-Nr.	
Pg 9	7.0	9.0	20	27	57	12	1809.26	25
Pg 11	9.0	11.0	24	30	57	12	1811.26	25
Pg 13	11.0	13.0	26	32	57	14	1813.26	25
Pg 16	11.0	13.0	26	32	57	14	1816.26	25
Pg 21	13.0	16.5	32	40	67	16	1821.26	10
Pg 21	16.5	20.0	36	44	67	16	1821.27	10
Pg 29	20.0	24.0	45	48	78	17	1829.26	5
Pg 29	24.0	28.0	45	52	78	17	1829.27	5
Pg 36	28.0	32.0	55	60	85	17	1836.26	5
Pg 36	32.0	36.0	55	64	85	17	1836.27	5
Pg 48	36.0	40.0	64	75	88	20	1848.48.26	1
Pg 48	40.0	44.0	64	80	88	20	1848.48.27	1

**Entry thread NPT**

G	>Ø< min mm	>Ø< max mm	 mm	ØA mm	H mm	L mm	Art.-Nr.	
NPT 3/8"	7.0	9.0	20	27	57	15.5	183/8NPT.09.26	25
NPT 1/2"	9.0	11.0	24	30	57	20	181/2NPT.11.26	25
NPT 1/2"	11.0	13.0	26	32	57	20	181/2NPT.16.26	25
NPT 3/4"	9.0	11.0	27	30	57	20	183/4NPT.11.26	25
NPT 3/4"	11.0	13.0	26	32	57	20	183/4NPT.16.26	25
NPT 3/4"	13.0	16.5	32	40	67	20	183/4NPT.21.26	10
NPT 1"	13.0	16.5	32	40	67	25	181NPT.21.26	10
NPT 1"	16.5	20.0	36	44	67	25	181NPT.21.27	10
NPT 1 1/4"	20.0	24.0	45	48	78	26	1811/4NPT.29.26	5
NPT 1 1/4"	24.0	28.0	45	52	78	26	1811/4NPT.29.27	5
NPT 1 1/2"	28.0	32.0	55	60	85	26	1811/2NPT.36.26	5
NPT 1 1/2"	32.0	36.0	55	64	85	26	1811/2NPT.36.27	5

**Gas-pipe entry thread**

G	>Ø< min mm	>Ø< max mm	 mm	ØA mm	H mm	L mm	Art.-Nr.	
G 3/8"	7.0	9.0	20	27	57	12	183/8G.09.26	25
G 1/2"	9.0	11.0	24	30	57	14	181/2G.11.26	25
G 1/2"	11.0	13.0	26	32	57	14	181/2G.16.26	25
G 3/4"	13.0	16.5	32	40	67	16	183/4G.21.26	10
G 3/4"	16.5	20.0	36	44	67	16	183/4G.21.27	10
G 1"	20.0	24.0	45	48	78	17	181G.29.26	5
G 1 1/4"	24.0	28.0	45	52	78	17	1811/4G.29.27	5
G 1 1/2"	28.0	32.0	55	60	85	17	1811/2G.36.26	5
G 2"	36.0	40.0	64	75	88	20	1848.26	1
G 2"	40.0	44.0	64	80	88	20	1848.27	1

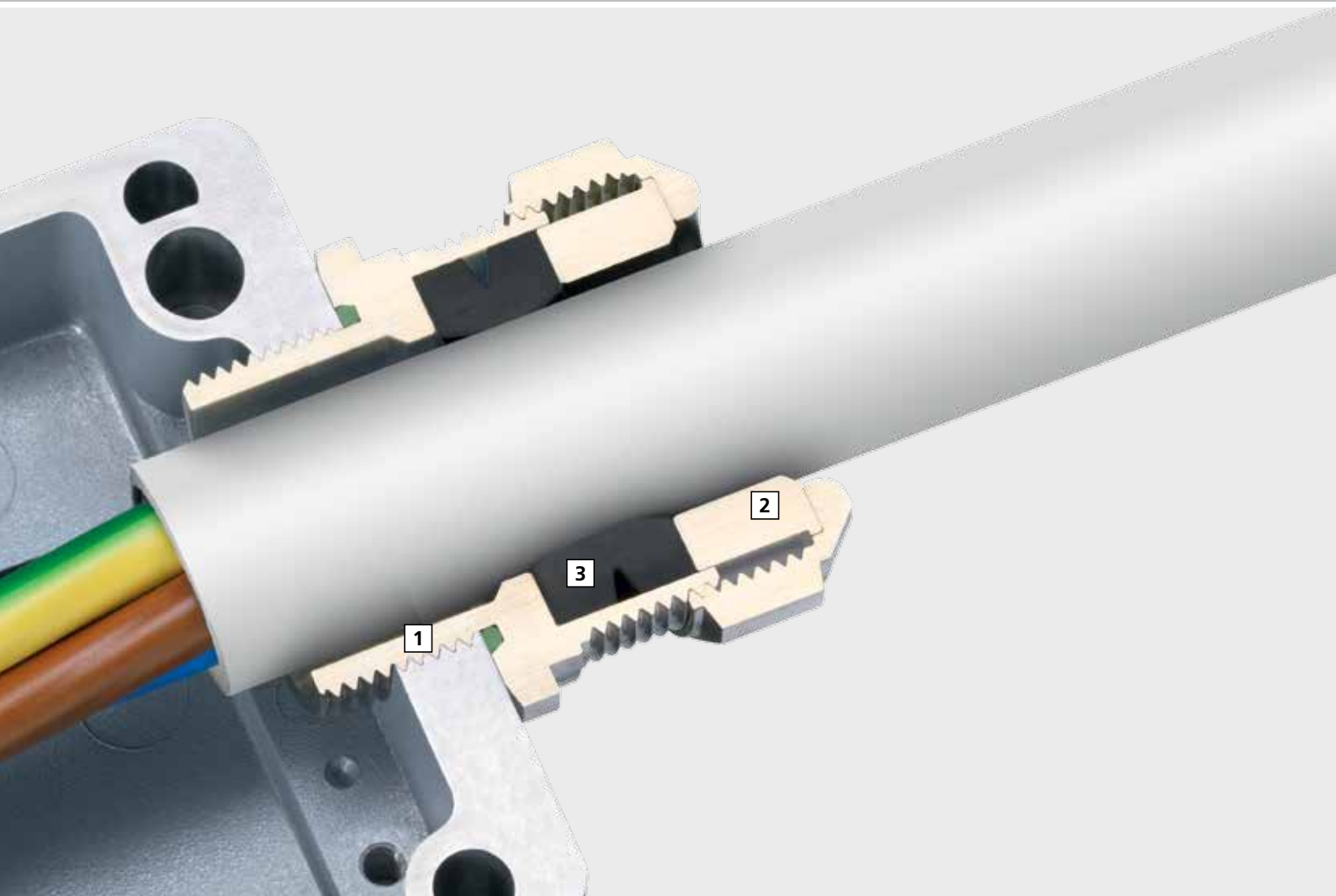

## Flameproof enclosures Ex d IIC and increased safety Ex e II

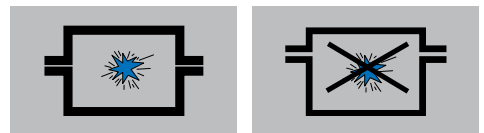

For a description of the protection type of flameproof enclosures, please see Page 8 of this brochure.

### Ex e II principle

In the case of ignition protection with an increased safety type, operation is based on the equipment preventing ignition of the explosive atmosphere which can also leak into the housing. The equipment may not reach temperatures which are above the temperature class of gases which could potentially arise in the place of use, and sparks caused by electrical or mechanical means may also not occur. In electrical machines, electrical-thermal testing is thus of particular importance. In operation, protection against overloading is essentially important to maintaining explosion protection.

### Important design parameters

- There are special protection requirements for non-insulated active components.
- Air and creepage gaps are dimensioned larger than is generally the case in industry. Special requirements apply to the IP protection classes which must be maintained.
- More stringent requirements apply to windings with mechanical stability and insulating capacity, and the windings must be protected against elevated temperatures.

### Applications

- Installation materials such as junction boxes and distribution boxes, terminal compartments for heaters, storage batteries, transformers, inductive ballasts, electrical motors, squirrel cage

induction motors, lighting fixtures.

Cable glands for increased safety are tested according to IEC/EN 60079-7 for the following points:

- mechanical design
- electrical-thermal testing

### 1 Entry threads

Long entry threads in metric designs allow maximum safety with respect to the quality of attachment.

### 2 Compact design

The compact design allows space-saving assembly on equipment, and the large clamping range reduces the number of different types.

### 3 Guaranteed sealing capability

The ingenious sealing insert and matching inner contours ensure a targeted deformation of the insert and thus guarantee its tightness. Protection Class IP68 (30 bar) facilitate optimal usage.

### Testing standards



EC 60079-0:2011 / EN 60079-0:2009  
IEC 60079-1:2007 / EN 60079-1:2007  
IEC 60079-31:2008 / EN 60079-31:2009

### Marking



II 2G Ex db eb IIC  
II 2D Ex ta IIIC  
Equipment protection Level Gb Da  
PTB 00 ATEX 1034X  
IECEx PTB 12.0055X





**Designation:** Ex Compact MS  
**Material:** Nickel-plated brass  
**Seal:** NBR  
 one-piece sealing insert, not overall length insulated  
**O-Ring :** FPM  
**Temperature range:** -60°C / +105°C  
**Protection class:** IP 68 (30 bar)  
**Test standard:** see page 10  
**Category 2G:** II 2G Ex db eb IIC  
**Category 2D:** II 2D Ex ta IIIC  
**Zone:** Gas 1 and 2 / dust 21 and 22  
**Certificate:** EC-type examination certificate PTB 10 ATEX 1034X  
**IECEX Certificate:** IECEX PTB 12.0055X  
**Approvals:**   

Entry thread metric

G	>Ø< min mm	>Ø< max mm	 mm	H mm	L mm	Art.-Nr.	
M16x1.5	3.0	7.0	21	26	12	EX1126.17.070	25
M16x1.5	5.0	10.0	24	26	12	EX1126.17.100	25
M20x1.5	5.0	11.0	24	26	12	EX1126.20.110	25
M20x1.5	9.0	14.0	30	26	12	EX1126.20.140	25
M25x1.5	7.5	15.0	32	28	12	EX1126.25.150	20
M25x1.5	12.5	18.0	32	28	12	EX1126.25.180	20
M32x1.5	17.0	23.0	41	33	12	EX1126.32.230	10
M32x1.5	21.0	26.0	41	33	12	EX1126.32.260	10
M40x1.5	21.0	26.0	41	33	14	EX1126.40.260	10
M40x1.5	24.0	32.0	50	34	14	EX1126.40.320	10
M50x1.5	28.0	36.0	55	34	14	EX1126.50.360	5
M50x1.5	35.0	42.0	60	35	14	EX1126.50.420	5
M63x1.5	36.0	44.0	65	35	14	EX1126.63.440	1
M63x1.5	43.0	50.0	70	35	14	EX1126.63.500	1

Available on request:

Executions in stainless steel A2 and A4, NPT entry threads



## Increased safety Ex e II

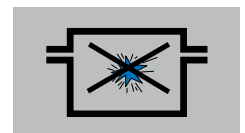

### Principle

In the case of ignition protection with an increased safety type, operation is based on the equipment preventing an ignition of the explosive atmosphere which can also leak into the housing. The equipment may not reach temperatures which are above the temperature class of gases which could potentially arise in the place of use, and sparks caused by electrical or mechanical means may also not occur. In electrical machines, electrical-thermal testing is thus of particular importance. In operation, protection against overloading is essentially important to maintaining explosion protection.

### Important design parameters

- Special protection requirements for non-insulated active components.
- Air and creepage gaps are dimensioned larger than is generally the case in industry. Special requirements apply to the IP protection classes which must be maintained.
- More stringent requirements apply to windings with mechanical stability and insulating capacity, and the windings must be protected against elevated temperatures.

### Applications

Installation materials such as junction boxes and distribution boxes, terminal compartments for heaters, storage batteries, transformers, inductive ballasts, electrical and squirrel cage induction motors, lighting fixtures. Cable glands for increased safety are tested according to IEC/EN 60079-7 for the following points:

- mechanical design
- electrical-thermal testing

### 1 Short, long or special entry threads

Progress® cable glands with short or long entry threads in metric or Pg designs can be used with existing threads or, in the case of drilled through holes, with locknuts.

### 2 Visible safety

The small bead on the sealing insert confirms the proper tightening torque.

### 3 High distortion protection

The integrated retaining grooves in the lower part and in the sealing insert ensure protection against twisting.

### 4 Guaranteed sealing capability

Inner contours matched to the sealing insert ensure a targeted deformation of the insert and thus guarantee its tightness. Protection Class IP68 to 10 bar as well as IP69K allow a wide range of uses.

### Testing standards

IEC 60079-0:2004 / EN 60079-0:2006  
 IEC 60079-7:2006 / EN 60079-7:2007  
 IEC 61241-0:2004 / EN 61241-0:2006  
 IECEx SEV 12.0002X

### Marking

II 2G Ex e II  
 Ex td A21 IP68  
 PTB 02 ATEX 1126X



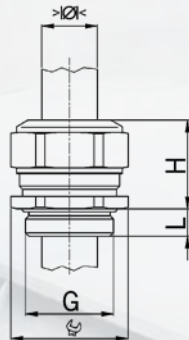

**Designation:** Progress MS EX  
**Material:** Nickel-plated brass  
**Seal:** TPE  
 one-piece sealing insert, not overall length insulated  
**Temperature range:** -40°C / +100°C  
**Protection class:** IP 68 (bis 10 bar) / IP 69K  
**Test standard:** see page 12  
**Category 2G:** Ex e II  
**Category 2D:** Ex tD A21 IP68  
**Zone:** Gas 1 and 2 / dust 21 and 22  
**Certificate:** EC-type examination certificate PTB 02 ATEX 1126X  
**IECEX Certificate:** IECEX SEV 12.0002X  
**Approvals:**

Short entry thread metric

G	>Ø< min mm	>Ø< max mm	 mm	H mm	L mm	i info	Art.-Nr.	
M8x1.25	3.0	3.5	11	14	5	1	EX1000.08.035	50
M8x1.25	4.0	5.0	11	14	5	1	EX1000.08.050	50
M10x1.5	3.0	4.0	13	15	5	1	EX1000.10.040	50
M10x1.5	4.5	6.0	13	15	5	1	EX1000.10.060	50
M12x1.5	5.0	6.5	15	17	5	-	EX1000.12.065	50
M12x1.5	6.5	8.0	15	17	5	-	EX1000.12.080	50
M16x1.5	4.5	6.0	18	20	5	-	EX1000.17.060	50
M16x1.5	6.0	8.0	18	20	5	-	EX1000.17.080	50
M20x1.5	6.0	8.0	24	21	6	-	EX1000.20.080	50
M20x1.5	8.0	11.0	24	21	6	-	EX1000.20.110	50
M25x1.5	9.5	12.5	30	25	7	-	EX1000.25.125	25
M25x1.5	12.5	16.0	30	27	7	-	EX1000.25.160	25
M32x1.5	14.0	17.0	36	28	8	-	EX1000.32.170	25
M32x1.5	17.0	21.0	36	28	8	-	EX1000.32.210	25
M40x1.5	20.0	24.0	46	31	8	-	EX1000.40.240	10
M40x1.5	24.0	28.5	46	31	8	-	EX1000.40.285	10

1 = Metric coarse-pitch thread

Short entry thread Pg

G	>Ø< min mm	>Ø< max mm	 mm	H mm	L mm	Art.-Nr.	
Pg 7	5.0	6.5	15	17	6	EX1000.07.065	50
Pg 7	6.5	8.0	15	17	6	EX1000.07.080	50
Pg 9	4.5	6.0	18	20	6	EX1000.09.060	50
Pg 9	6.0	8.0	18	20	6	EX1000.09.080	50
Pg 11	4.0	5.5	21	21	6	EX1000.11.055	50
Pg 11	5.5	8.5	21	21	6	EX1000.11.085	50
Pg 13	6.0	8.0	24	21	6	EX1000.13.080	50
Pg 13	8.0	11.0	24	21	6	EX1000.13.110	50
Pg 16	6.0	8.0	24	21	6	EX1000.16.080	50
Pg 16	8.0	11.0	24	21	6	EX1000.16.110	50
Pg 21	9.5	12.5	30	25	7.5	EX1000.21.125	25
Pg 21	12.5	16.0	30	25	7.5	EX1000.21.160	25
Pg 29	16.0	19.0	38	28	8	EX1000.29.190	25
Pg 29	19.0	23.0	38	28	8	EX1000.29.230	25
Pg 36	21.5	26.0	50	32	8	EX1000.36.260	10
Pg 36	26.0	30.5	50	32	8	EX1000.36.305	10

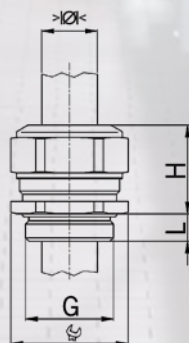

**Designation:** Progress MS EX  
**Material:** nickel-plated brass  
**Seal:** TPE  
 one-piece sealing insert, not overall length insulated  
**Temperature range:** -40°C / +100°C  
**Protection class:** IP 68 (bis 10 bar) / IP 69K  
**Test standard:** see page 12  
**Category 2G:** Ex e II  
**Category 2D:** Ex tD A21 IP68  
**Zone:** Gas 1 and 2 / dust 21 and 22  
**Certificate:** EC-type examination certificate PTB 02 ATEX 1126X  
**IECEX Certificate:** IECEX SEV 12.0002X  
**Approvals:**

Long entry thread metric

G	>Ø< min mm	>Ø< max mm	 mm	H mm	L mm	i info	Art.-Nr.	
M8x1.25	3.0	3.5	11	14	10	1	EX1100.08.035	50
M8x1.25	4.0	5.0	11	14	10	1	EX1100.08.050	50
M10x1.5	3.0	4.0	13	15	10	1	EX1100.10.040	50
M10x1.5	4.5	6.0	13	15	10	1	EX1100.10.060	50
M12x1.5	5.0	6.5	15	17	10	-	EX1100.12.065	50
M12x1.5	6.5	8.0	15	17	10	-	EX1100.12.080	50
M16x1.5	4.5	6.0	18	20	10	-	EX1100.17.060	50
M16x1.5	6.0	8.0	18	20	10	-	EX1100.17.080	50
M20x1.5	6.0	8.0	24	21	10	-	EX1100.20.080	50
M20x1.5	8.0	11.0	24	21	10	-	EX1100.20.110	50
M25x1.5	9.5	12.5	30	25	11	-	EX1100.25.125	25
M25x1.5	12.5	16.0	30	27	11	-	EX1100.25.160	25
M32x1.5	14.0	17.0	36	28	13	-	EX1100.32.170	25
M32x1.5	17.0	21.0	36	28	13	-	EX1100.32.210	25
M40x1.5	20.0	24.0	46	31	13	-	EX1100.40.240	10
M40x1.5	24.0	28.5	46	31	13	-	EX1100.40.285	10

1 = Metric coarse-pitch thread

Long entry thread Pg

G	>Ø< min mm	>Ø< max mm	 mm	H mm	L mm	Art.-Nr.	
Pg 7	5.0	6.5	15	17	10	EX1100.07.065	50
Pg 7	6.5	8.0	15	17	10	EX1100.07.080	50
Pg 9	4.5	6.0	18	20	10	EX1100.09.060	50
Pg 9	6.0	8.0	18	20	10	EX1100.09.080	50
Pg 11	4.0	5.5	21	21	10	EX1100.11.055	50
Pg 11	5.5	8.5	21	21	10	EX1100.11.085	50
Pg 13	6.0	8.0	24	21	10	EX1100.13.080	50
Pg 13	8.0	11.0	24	21	10	EX1100.13.110	50
Pg 16	6.0	8.0	24	21	10	EX1100.16.080	50
Pg 16	8.0	11.0	24	21	10	EX1100.16.110	50
Pg 21	9.5	12.5	30	25	12	EX1100.21.125	25
Pg 21	12.5	16.0	30	25	12	EX1100.21.160	25
Pg 29	16.0	19.0	38	28	12	EX1100.29.190	25
Pg 29	19.0	23.0	38	28	12	EX1100.29.230	25
Pg 36	21.5	26.0	50	32	15	EX1100.36.260	10
Pg 36	26.0	30.5	50	32	15	EX1100.36.305	10



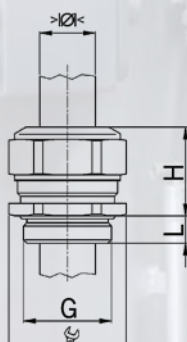

**Designation:** Progress MS Multi EX  
**Material:** Nickel-plated brass  
**Seal:** TPE / NBR  
 one-piece sealing insert, not overall length insulated  
**Temperature range:** -40°C / +100°C  
**Protection class:** IP 68  
**Test standard:** see page 12  
**Category 2G:** Ex e II  
**Category 2D:** Ex tD A21 IP68  
**Zone:** Gas 1 and 2 / dust 21 and 22  
**Certificate:** EC-type examination certificate PTB 02 ATEX 1126X  
**IECEX Certificate:** IECEX SEV 12.0002X  
**Approvals:**

Short entry thread metric

G	>Ø< min mm	>Ø< max mm			H mm	L mm	i info	Art.-Nr.	
M12x1.5	0.6	1.0	3	15	17	5	3	EX1310.12.3.010	50
M16x1.5	1.0	1.5	4	18	20	5	3	EX1310.17.4.015	50
M16x1.5	2.0	3.0	2	18	20	5	-	EX1310.17.2.030	50
M20x1.5	2.5	3.0	6	24	21	6	-	EX1310.20.6.030	50
M20x1.5	3.5	5.0	2	24	21	6	-	EX1310.20.2.050	50
M20x1.5	3.5	5.0	4	24	21	6	-	EX1310.20.4.050	50
M20x1.5	4.5	6.0	3	24	21	6	-	EX1310.20.3.060	50
M20x1.5	5.5	7.5	2	24	21	6	-	EX1310.20.2.075	50
M25x1.5	5.0	6.0	6	30	25	7	-	EX1310.25.6.060	25
M25x1.5	6.0	7.0	3	30	25	7	-	EX1310.25.3.070	25
M25x1.5	5.5	7.0	4	30	25	7	-	EX1310.25.4.070	25
M25x1.5	7.5	9.0	3	30	25	7	-	EX1310.25.3.090	25
M25x1.5	8.0	10.0	2	30	25	7	-	EX1310.25.2.100	25
M32x1.5	6.0	7.0	6	36	28	8	-	EX1310.32.6.070	25
M32x1.5	7.5	9.0	4	36	28	8	-	EX1310.32.4.090	25
M40x1.5	8.0	9.0	7	46	31	8	3	EX1310.40.7.090	10
M40x1.5	14.0	15.0	2	46	31	8	3	EX1310.40.2.150	10
M50x1.5	9.0	10.0	4	55	34	9	3	EX1310.50.4.100	10
M63x1.5	11.0	12.0	6	70	37	10	3	EX1310.63.6.120	5
M63x1.5	17.0	18.0	3	70	37	10	3	EX1310.63.3.180	5

3 = Material sealing insert NBR

Short entry thread Pg

G	>Ø< min mm	>Ø< max mm			H mm	L mm	i info	Art.-Nr.	
Pg 9	1.0	1.5	4	18	20	6	3	EX1310.09.4.015	50
Pg 9	2.0	3.0	2	18	20	6	-	EX1310.09.2.030	50
Pg 11	2.0	3.0	3	21	21	6	3	EX1310.11.3.030	50
Pg 11	3.0	4.0	2	21	21	6	3	EX1310.11.2.040	50
Pg 11	3.5	5.0	2	21	21	6	-	EX1310.11.2.050	50
Pg 13	2.5	4.0	3	24	23	6	3	EX1310.13.3.040	50
Pg 13	3.5	5.0	2	24	23	6	-	EX1310.13.2.050	50
Pg 16	2.5	3.0	6	24	23	6	-	EX1310.16.6.030	50
Pg 16	3.0	4.0	6	24	23	6	3	EX1310.16.6.040	50
Pg 16	4.5	6.0	2	24	23	6	-	EX1310.16.2.060	50
Pg 16	4.5	6.0	3	24	23	6	-	EX1310.16.3.060	50
Pg 21	5.5	7.0	4	30	28	7	-	EX1310.21.4.070	25
Pg 21	7.5	9.0	3	30	28	7	-	EX1310.21.3.090	25
Pg 29	5.5	6.5	6	38	28	8	3	EX1310.29.6.065	25
Pg 29	8.0	9.0	3	38	28	8	3	EX1310.29.3.090	25
Pg 36	9.0	10.0	4	50	32	8	3	EX1310.36.4.100	10
Pg 36	14.0	15.0	2	50	32	8	3	EX1310.36.2.150	10
Pg 48	11.0	12.0	6	65	37	11	3	EX1310.48.6.120	5
Pg 48	17.0	18.0	3	65	37	11	3	EX1310.48.3.180	5

3 = Material sealing insert NBR

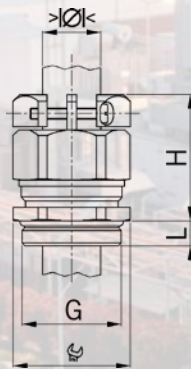

**Designation:** Progress MS KB EX  
**Material:** Nickel-plated brass  
**Screws:** Stainless steel A2  
**Seal:** TPE  
 one-piece sealing insert, not overall length insulated  
**Temperature range:** -40°C / +100°C  
**Protection class:** IP 68 (bis 10 bar) / IP 69K  
**Test standard:** see page 12  
**Category 2G:** Ex e II  
**Category 2D:** Ex tD A21 IP68  
**Zone:** Gas 1 and 2 / dust 21 and 22  
**Certificate:** EC-type examination certificate PTB 02 ATEX 1126X  
**IECEX Certificate:** IECEX SEV 12.0002X  
**Approvals:**

**Short entry thread metric**

G	>Ø< min mm	>Ø< max mm	 mm	H mm	L mm	Art.-Nr.	
M12x1.5	5.0	6.5	15/16	26	5	EX1803.12.03.065	50
M12x1.5	6.5	8.0	15/16	26	5	EX1803.12.03.080	50

**Short entry thread Pg**

G	>Ø< min mm	>Ø< max mm	 mm	H mm	L mm	Art.-Nr.	
Pg 7	5.0	6.5	15/16	26	6	EX1803.07.03.065	50
Pg 7	6.5	8.0	15/16	26	6	EX1803.07.03.080	50

**Available on request:**

- Cable glands nickel-plated brass with long entry thread
- Cable glands nickel-plated brass with FPM sealing insert for high temperature applications (+200°C)
- Cable glands stainless steel A2 with long entry thread
- Cable glands stainless steel Stahl A2 or acid proof stainless steel A4 with long entry thread and FPM sealing insert for high temperature applications (+200°C)



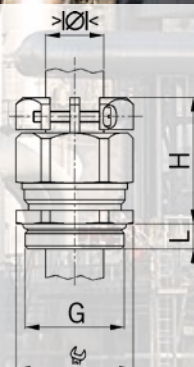

**Designation:** Progress MS KB EX  
**Material:** Nickel-plated brass  
**Screws:** Stainless steel A2  
**Seal:** TPE  
 two-piece sealing insert, not overall length insulated  
**Temperature range:** -40°C / +100°C  
**Protection class:** IP 68 (bis 10 bar) / IP 69K  
**Test standard:** see page 12  
**Category 2G:** Ex e II  
**Category 2D:** Ex tD A21 IP68  
**Zone:** Gas 1 and 2 / dust 21 and 22  
**Certificate:** EC-type examination certificate PTB 02 ATEX 1125  
**IECEx Certificate:** IECEx SEV 12.0001  
**Approvals:**

**Short entry thread metric**

G	>Ø< min mm	>Ø< max mm	 mm	H mm	L mm	Art.-Nr.	
M16x1.5	6.0	10.5	18/19	30	5	EX1803.17	50
M20x1.5	8.0	15.0	24	31	6	EX1803.20	50
M25x1.5	12.5	20.5	30	35	7	EX1803.25	25
M32x1.5	17.0	25.5	36	40	8	EX1803.32	25
M40x1.5	24.0	33.0	46	44	8	EX1803.40	10
M50x1.5	33.0	42.0	55	49	9	EX1803.50	10
M63x1.5	40.0	52.0	70	55	10	EX1803.63	5

**Short entry thread Pg**

G	>Ø< min mm	>Ø< max mm	 mm	H mm	L mm	Art.-Nr.	
Pg 9	6.0	10.5	18/19	30	6	EX1803.09	50
Pg 11	5.5	12.0	21	31	6	EX1803.11	50
Pg 13	8.0	15.0	24	31	6	EX1803.13	50
Pg 16	8.0	15.0	24	31	6	EX1803.16	50
Pg 21	12.5	20.5	30	35	7.5	EX1803.21	25
Pg 29	19.0	27.5	38	40	8	EX1803.29	25
Pg 36	26.0	35.0	50	47	8	EX1803.36	10
Pg 42	33.0	42.0	55	49	10	EX1803.42	10
Pg 48	37.0	49.0	65	51	11	EX1803.48	5

**Available on request:**

- Cable glands nickel-plated brass with long entry thread
- Cable glands nickel-plated brass with FPM sealing insert for high temperature applications (+200°C)
- Cable glands stainless steel A2 with long entry thread
- Cable glands stainless steel Stahl A2 or acid proof stainless steel A4 with long entry thread and FPM sealing insert for high temperature applications (+200°C)

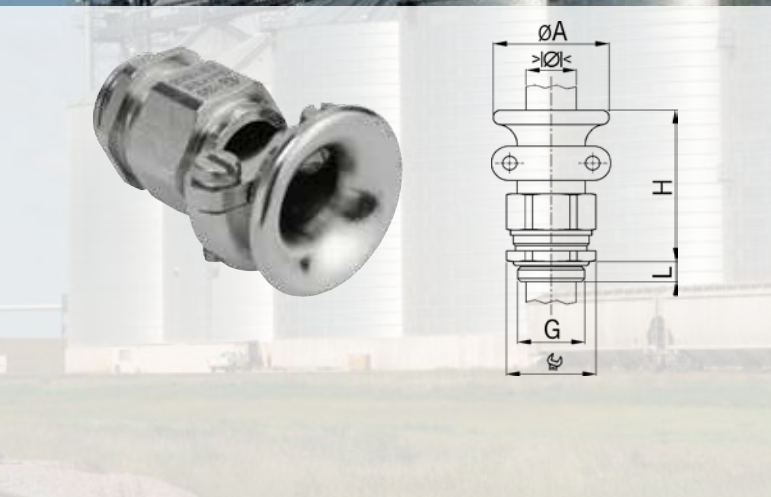

**Designation:** Progress MS T+KB EX  
**Material:** Nickel-plated brass  
**Screws:** Stainless steel A2  
**Seal:** TPE  
 two-piece sealing insert, not overall length insulated  
**Temperature range:** -40°C / +100°C  
**Protection class:** IP 68 (bis 10 bar) / IP 69K  
**Test standard:** see page 12  
**Category 2G:** Ex e II  
**Category 2D:** Ex tD A21 IP68  
**Zone:** Gas 1 and 2 / dust 21 and 22  
**Certificate:** EC-type examination certificate PTB 02 ATEX 1125  
**IECEX Certificate:** IECEX SEV 12.0001  
**Approvals:**

Short entry thread metric

G	>Ø< min mm	>Ø< max mm	 mm	ØA mm	H mm	L mm	Art.-Nr.	
M16x1.5	6.0	10.5	18	28	43	5	EX1801.17	50
M20x1.5	8.0	15.0	24	34	46	6	EX1801.20	50
M25x1.5	12.5	20.5	30	44	52	7	EX1801.25	25
M32x1.5	17.0	25.5	36	50	59	8	EX1801.32	10
M40x1.5	24.0	33.0	46	57	59	8	EX1801.40	5

Short entry thread Pg

G	>Ø< min mm	>Ø< max mm	 mm	ØA mm	H mm	L mm	Art.-Nr.	
Pg 9	6.0	10.5	18	28	43	6	EX1801.09	50
Pg 11	5.5	12.0	21	30	43	6	EX1801.11	50
Pg 13	8.0	15.0	24	34	46	6	EX1801.13	50
Pg 16	8.0	15.0	24	34	46	6	EX1801.16	50
Pg 21	12.5	20.5	30	44	52	7.5	EX1801.21	25
Pg 29	19.0	27.5	38	50	59	8	EX1801.29	10

Long entry thread metric

G	>Ø< min mm	>Ø< max mm	 mm	ØA mm	H mm	L mm	Art.-Nr.	
M16x1.5	6.0	10.5	18	28	43	10	EX1811.17	50
M20x1.5	8.0	15.0	24	34	46	10	EX1811.20	50
M25x1.5	12.5	20.5	30	44	52	11	EX1811.25	25
M32x1.5	17.0	25.5	36	50	59	13	EX1811.32	10
M40x1.5	24.0	33.0	46	57	59	13	EX1811.40	5

Long entry thread Pg

G	>Ø< min mm	>Ø< max mm	 mm	ØA mm	H mm	L mm	Art.-Nr.	
Pg 9	6.0	10.5	18	28	43	10	EX1811.09	50
Pg 11	5.5	12.0	21	30	43	10	EX1811.11	50
Pg 13	8.0	15.0	24	34	46	10	EX1811.13	50
Pg 16	8.0	15.0	24	34	46	10	EX1811.16	50
Pg 21	12.5	20.5	30	44	52	12	EX1811.21	25
Pg 29	19.0	27.5	38	50	59	12	EX1811.29	10

Available on request:

- Cable glands nickel-plated brass with trumpet and clamps and FPM sealing insert for high temperature applications (+200°C)



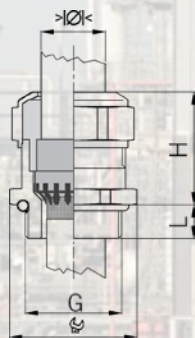

**Designation:** Progress MS EMV Rapid EX  
**Material:** Nickel-plated brass  
**Seal:** TPE  
 one-piece sealing insert, not overall length insulated  
**O-Ring :** NBR  
**Temperature range:** -40°C / +100°C  
**Protection class:** IP 68 (bis 10 bar) / IP 69K  
**Test standard:** see page 12  
**Category 2G:** Ex e II  
**Category 2D:** Ex tD A21 IP68  
**Zone:** Gas 1 and 2 / dust 21 and 22  
**Certificate:** EC-type examination certificate PTB 02 ATEX 1126X  
**IECEx Certificate:** IECEx SEV 12.0002X  
**Eigenschaften:** For a quick installation of partially dismantled cables as well as for thoroughly shielded cables

**Approvals:**

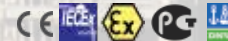

**Short entry thread metric**

G	>Ø< min mm	>Ø< max mm	mm	H mm	L mm	Art.-Nr.	
M12x1.5	4.5	6.0	15	20	5	EX1081.12.060	50
M12x1.5	6.0	7.5	15	20	5	EX1081.12.075	50
M16x1.5	6.0	8.0	18	23	5	EX1081.17.080	50
M16x1.5	8.0	10.0	18	25	5	EX1081.17.100	50
M20x1.5	8.0	11.0	24	25	6	EX1081.20.110	50
M20x1.5	11.0	14.0	24	27	6	EX1081.20.140	50
M25x1.5	13.0	16.0	30	30	7	EX1081.25.160	25
M25x1.5	16.0	19.0	30	33	7	EX1081.25.190	25
M32x1.5	18.0	21.0	36	32	8	EX1081.32.210	25

**Available on request:**

Long entry thread

**Short entry thread Pg**

G	>Ø< min mm	>Ø< max mm	mm	H mm	L mm	Art.-Nr.	
Pg 7	4.5	6.0	15	20	6	EX1081.07.060	50
Pg 7	6.0	7.5	15	20	6	EX1081.07.075	50
Pg 9	6.0	8.0	18	23	6	EX1081.09.080	50
Pg 9	8.0	10.0	18	25	6	EX1081.09.100	50
Pg 11	5.5	8.5	21	25	6	EX1081.11.085	50
Pg 11	8.5	12.0	21	25	6	EX1081.11.120	50
Pg 13	8.0	11.0	24	25	6	EX1081.13.110	50
Pg 13	12.5	14.0	24	27	6	EX1081.13.140	50
Pg 16	8.0	11.0	24	24	6	EX1081.16.110	50
Pg 16	12.5	14.0	24	27	6	EX1081.16.140	50
Pg 21	13.0	16.0	30	30	7	EX1081.21.160	25
Pg 21	17.0	19.0	30	33	7	EX1081.21.190	25
Pg 29	19.0	23.0	38	33	8	EX1081.29.230	25
Pg 29	23.0	25.5	38	32	8	EX1081.29.255	25



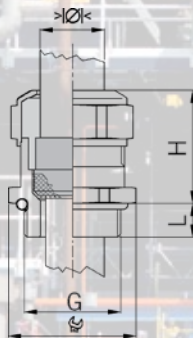

**Designation:** Progress MS EMV EX  
**Material:** Nickel-plated brass  
**Seal:** TPE  
 one-piece sealing insert, not overall length insulated  
**O-Ring :** NBR  
**Temperature range:** -40°C / +100°C  
**Protection class:** IP 68 (bis 10 bar) / IP 69K  
**Test standard:** see page 12  
**Category 2G:** Ex e II  
**Category 2D:** Ex tD A21 IP68  
**Zone:** Gas 1 and 2 / dust 21 and 22  
**Certificate:** EC-type examination certificate PTB 02 ATEX 1126X  
**IECEX Certificate:** IECEX SEV 12.0002X  
**Properties:** Excellent shield contact through the contact sleeve with the braided shield terminating within the cable gland  
**Approvals:**

**Short entry thread metric**

G	>Ø< min mm	>Ø< max mm	 mm	H mm	L mm	i info	Art.-Nr.	
M8x1.25	2.5	3.5	11	15	5	1	EX1080.08.035	50
M8x1.25	3.0	4.0	11	15	5	1	EX1080.08.040	50
M10x1.5	3.0	4.0	13	16	5	1	EX1080.10.040	50
M10x1.5	4.0	6.0	13	16	5	1	EX1080.10.060	50
M12x1.5	4.5	6.0	15	20	5	-	EX1080.12.060	50
M12x1.5	6.0	7.5	15	20	5	-	EX1080.12.075	50
M16x1.5	6.0	8.0	18	23	5	-	EX1080.17.080	50
M16x1.5	8.0	10.0	18	25	5	-	EX1080.17.100	50
M20x1.5	8.0	11.0	24	25	6	-	EX1080.20.110	50
M20x1.5	12.5	14.0	24	27	6	-	EX1080.20.140	50
M25x1.5	13.0	16.0	30	30	7	-	EX1080.25.160	25
M25x1.5	17.0	19.0	30	33	7	-	EX1080.25.190	25
M32x1.5	17.0	21.0	36	32	8	-	EX1080.32.210	25
M40x1.5	23.0	28.5	46	34	8	-	EX1080.40.285	10

1 = Metric coarse-pitch thread





**Short entry thread Pg**

G	>Ø< min mm	>Ø< max mm	 mm	H mm	L mm	Art.-Nr.	
Pg 7	4.5	6.0	15	20	6	EX1080.07.060	50
Pg 7	6.0	7.5	15	20	6	EX1080.07.075	50
Pg 9	6.0	8.0	18	23	6	EX1080.09.080	50
Pg 9	8.0	10.0	18	25	6	EX1080.09.100	50
Pg 11	5.5	8.5	21	23	6	EX1080.11.085	50
Pg 11	9.5	12.0	21	23	6	EX1080.11.120	50
Pg 13	8.0	11.0	24	25	6	EX1080.13.110	50
Pg 13	12.5	14.0	24	27	6	EX1080.13.140	50
Pg 16	8.0	11.0	24	24	6	EX1080.16.110	50
Pg 16	12.5	14.0	24	27	6	EX1080.16.140	50
Pg 21	13.0	16.0	30	30	7.5	EX1080.21.160	25
Pg 21	17.0	19.0	30	33	7.5	EX1080.21.190	25
Pg 29	19.0	23.0	38	33	8	EX1080.29.230	25
Pg 29	24.0	25.5	38	32	8	EX1080.29.255	25
Pg 36	25.0	30.5	50	36	8	EX1080.36.305	10

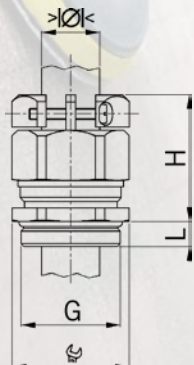

Available on request:

Long entry thread





**Designation:** Progress MS EMV KB EX  
**Material:** Nickel-plated brass  
**Screws:** Stainless steel A2  
**Seal:** TPE  
 one-piece sealing insert, not overall length insulated  
**Temperature range:** -40°C / +100°C  
**Protection class:** IP 68 (bis 10 bar) / IP 69K  
**Test standard:** see page 12  
**Category 2G:** Ex e II  
**Category 2D:** Ex tD A21 IP68  
**Zone:** Gas 1 and 2 / dust 21 and 22  
**Certificate:** EC-type examination certificate PTB 02 ATEX 1125  
**IECEX Certificate:** IECEX SEV 12.0001  
**Approvals:**     

Short entry thread metric

G	>Ø< min mm	>Ø< max mm	 mm	H mm	L mm	Art.-Nr.	
M12x1.5	4.5	6.0	15/16	26	5	EX1803.80.12.060	50
M12x1.5	6.0	7.5	15/16	26	5	EX1803.80.12.075	50
M16x1.5	6.0	8.0	18/19	30	5	EX1803.80.17.080	50
M16x1.5	8.0	10.0	18/19	30	5	EX1803.80.17.100	50
M20x1.5	8.0	11.0	24	31	6	EX1803.80.20.110	50
M20x1.5	11.0	14.0	24	31	6	EX1803.80.20.140	50
M25x1.5	13.0	16.0	30	35	7	EX1803.80.25.160	25
M25x1.5	16.0	19.0	30	35	7	EX1803.80.25.190	25
M32x1.5	18.0	21.0	36	40	8	EX1803.80.32.210	25
M32x1.5	21.0	25.0	36	40	8	EX1803.80.32.250	25
M40x1.5	24.0	28.5	46	44	8	EX1803.80.40.285	10
M40x1.5	28.5	32.0	46	44	8	EX1803.80.40.320	10
M50x1.5	33.0	37.0	55	49	9	EX1803.80.50.370	10
M50x1.5	37.0	41.0	55	49	9	EX1803.80.50.410	10
M63x1.5	40.0	46.0	70	55	10	EX1803.80.63.460	5
M63x1.5	46.0	50.0	70	55	10	EX1803.80.63.500	5

Short entry thread Pg

G	>Ø< min mm	>Ø< max mm	 mm	H mm	L mm	Art.-Nr.	
Pg 7	4.5	6.0	15/16	26	6	EX1803.80.07.060	50
Pg 7	6.0	7.5	15/16	26	6	EX1803.80.07.075	50
Pg 9	6.0	8.0	18/19	30	6	EX1803.80.09.080	50
Pg 9	8.0	10.0	18/19	30	6	EX1803.80.09.100	50
Pg 11	5.5	8.5	21	31	6	EX1803.80.11.085	50
Pg 11	8.5	12.0	21	31	6	EX1803.80.11.120	50
Pg 13	8.0	11.0	24	31	6	EX1803.80.13.110	50
Pg 13	11.0	14.0	24	31	6	EX1803.80.13.140	50
Pg 16	8.0	11.0	24	31	6	EX1803.80.16.110	50
Pg 16	11.0	14.0	24	31	6	EX1803.80.16.140	50
Pg 21	13.0	16.0	30	35	7.5	EX1803.80.21.160	25
Pg 21	16.0	19.0	30	35	7.5	EX1803.80.21.190	25
Pg 29	19.0	23.0	38	40	8	EX1803.80.29.230	25
Pg 29	23.0	25.5	38	40	8	EX1803.80.29.255	25
Pg 36	25.0	30.5	50	47	8	EX1803.80.36.305	10
Pg 36	30.5	35.0	50	47	8	EX1803.80.36.350	10
Pg 42	33.0	37.0	55	49	10	EX1803.80.42.370	10
Pg 42	37.0	41.0	55	49	10	EX1803.80.42.410	10
Pg 48	39.0	43.0	65	51	11	EX1803.80.48.430	5
Pg 48	43.0	46.5	65	51	11	EX1803.80.48.465	5

Available on request:

Long entry thread



EMC cable gland Series 85 with clamps increased safety Ex e II



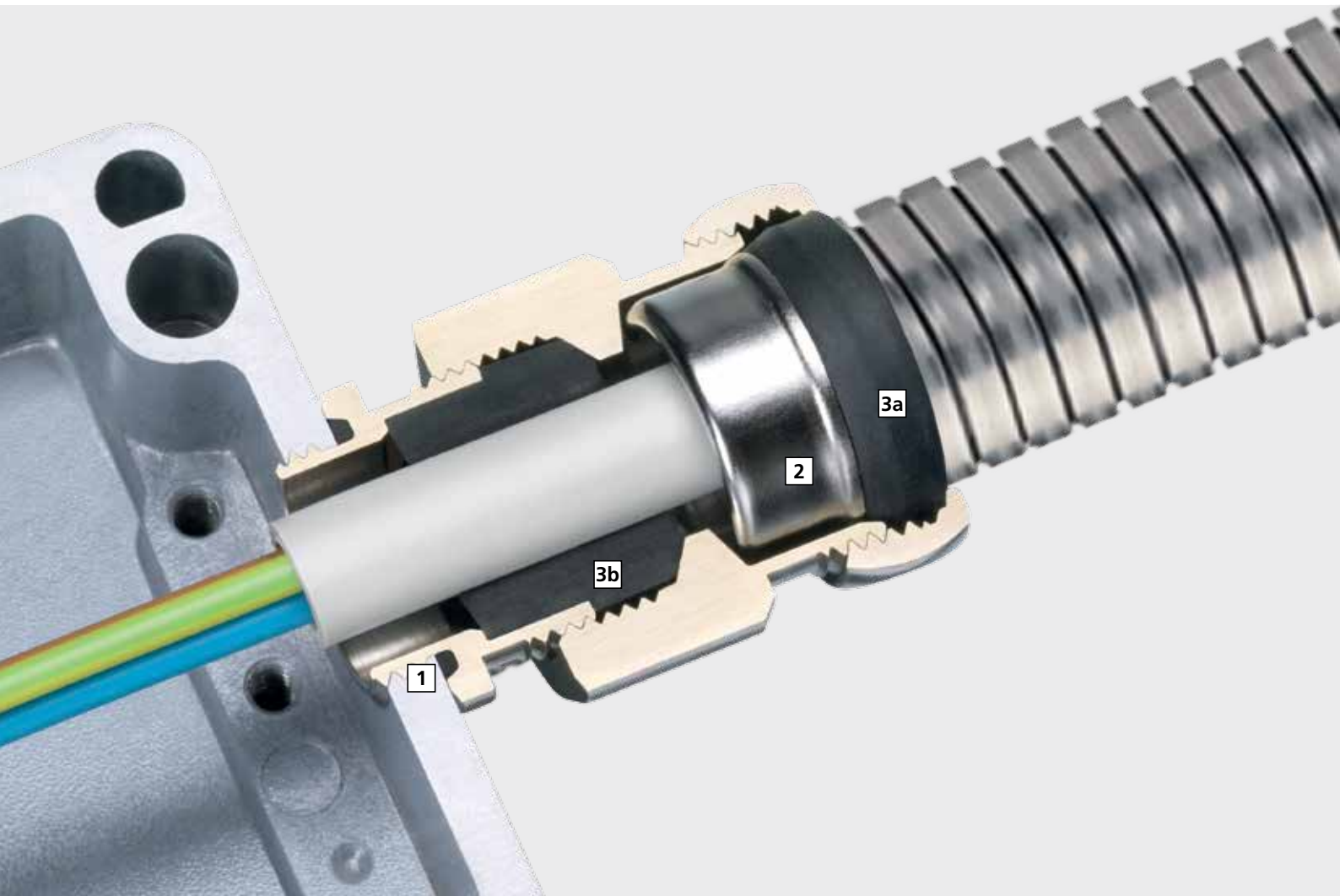

## Increased safety Ex e II

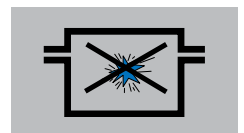

### Principle

In the case of ignition protection with an increased safety type, operation is based on the equipment preventing an ignition of the explosive atmosphere which can also leak into the housing. The equipment may not reach temperatures which are above the temperature class of gases which could potentially arise in the place of use, and sparks caused by electrical or mechanical means may also not occur. In electrical machines, electrical-thermal testing is thus of particular importance. In operation, protection against overloading is essentially important to maintaining explosion protection.

AGRO combination conduit glands provide an optimal mix if you want to feed cables inside a conduit into an enclosure and at the same time want a secure seal and strain relief for the cables.

### Attention!

Only metallic or metal-braided conduits may be applied!

### Important design parameters

- There are special protection requirements for non-insulated active components.
- Air and creepage gaps are dimensioned larger than is generally the case in industry. Special requirements apply to the IP protection classes which must be maintained.
- More stringent requirements apply to windings with mechanical stability and insulating capacity, and the windings must be protected against elevated temperatures.

### Applications

For installations where cable protection is important such as metal-working machines or where mechanical damage can occur or effects due to weather must be excluded.

Conduit glands for increased safety are tested according to IEC/EN 60079-7 for the following points:

- mechanical design
- electrical-thermal testing

### 1 Short entry threads, metric

Progress® cable glands with short entry threads can be used with existing screw threads.

### 2 Grounding

The screened tap connection is accomplished with a brass contact sleeve instead of the gasket (3a) over 360°.

### 3 Guaranteed sealing capability

The sealing capability of the combination conduit gland is ensured not only between the conduit and the conduit gland (3a) but also through the sealing insert in the cable gland (3b) at the entrance into the housing.

### Testing standards

IEC 60079-0:2004 / EN 60079-0:2006  
IEC 60079-7:2006 / EN 60079-7:2007  
IEC 61241-0:2004 / EN 61241-0:2006

### Marking

II 2G Ex e II  
Ex td A21 IP68  
PTB 02 ATEX 1122X  
IECEx SEV 12.0004X



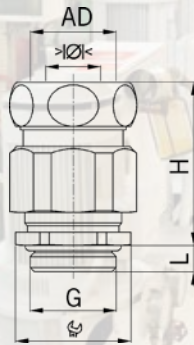

**Designation:** Progress MS Kombi EX  
**Material:** Nickel-plated brass  
**Seal:** TPE / NBR  
 one-piece sealing insert, not overall length insulated  
**Temperature range:** -40°C / +100°C  
**Protection class:** IP 68  
**Test standard:** see page 22  
**Category 2G:** Ex e II  
**Category 2D:** Ex tD A21 IP68  
**Zone:** Gas 1 and 2 / Staub 21 and 22  
**Certificate:** EC-type examination certificate PTB 11 ATEX 1022X  
**IECEx Certificate:** IECEx SEV 12.0004X  
**Approvals:**

Short entry thread metric

G	AD mm	>Ø< min mm	>Ø< max mm	 mm	H mm	L mm	Art.-Nr.	
M12x1.5	10	4.0	6.5	15/17	33	5	EX1700.12.10.065	25
M16x1.5	14	4.5	6.0	18/21	38	5	EX1700.17.14.060	25
M16x1.5	14	6.0	8.0	18/21	38	5	EX1700.17.14.080	25
M16x1.5	14	8.5	10.5	18/21	38	5	EX1700.17.14.105	25
M20x1.5	17	6.5	8.0	24/25	38	6	EX1700.20.17.080	25
M20x1.5	17	9.5	11.0	24/25	38	6	EX1700.20.17.110	25
M20x1.5	19	6.5	8.0	24/27	39	6	EX1700.20.19.080	25
M20x1.5	19	9.5	11.0	24/27	39	6	EX1700.20.19.110	25
M20x1.5	19	12.0	15.0	24/27	39	6	EX1700.20.19.150	25
M20x1.5	21	6.5	8.0	24/29	39	6	EX1700.20.21.080	25
M20x1.5	21	9.5	11.0	24/29	39	6	EX1700.20.21.110	25
M20x1.5	21	12.0	15.0	24/29	39	6	EX1700.20.21.150	25
M25x1.5	21	10.5	12.5	30/29	43	7	EX1700.25.21.125	25
M25x1.5	21	13.0	16.0	30/29	43	7	EX1700.25.21.160	25
M25x1.5	27	10.5	12.5	30/36	50	7	EX1700.25.27.125	25
M25x1.5	27	13.0	16.0	30/36	50	7	EX1700.25.27.160	25
M25x1.5	27	17.0	20.5	30/36	50	7	EX1700.25.27.205	25
M32x1.5	27	19.0	21.0	36/36	52	8	EX1700.32.27.210	25
M40x1.5	36	25.0	28.5	45/45	56	8	EX1700.40.36.285	25
M50x1.5	45	35.0	37.0	55/54	60	9	EX1700.50.45.370	1
M63x1.5	56	44.0	46.0	70/66	67	10	EX1700.63.56.460	1

Available on request:

Long entry thread

Depending on the type of conduit, the stabilising bush must be ordered separately.

**Warning: Only metallic conduits or conduits with metallic braiding may be applied!**



## Increased safety Ex e II

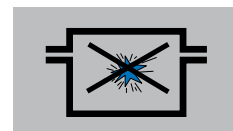

### Principle

In the case of ignition protection with an increased safety type, operation is based on the equipment preventing an ignition of the explosive atmosphere which can also leak into the housing. The equipment may not reach temperatures which are above the temperature class of gases which could potentially arise in the place of use, and sparks caused by electrical or mechanical means may also not occur. This applies not only to normal operation but also during predictable malfunctions. In electrical machines, electrical-thermal testing is thus of particular importance. In operation, protection against overloading is essentially important to maintaining explosion protection.

### Important design parameters

- Special protection requirements for non-insulated active components.
- Air and creepage gaps are dimensioned larger than is generally the case in industry. Special requirements apply to the IP protection classes which must be maintained.
- More stringent requirements apply to windings with mechanical stability and insulating capacity, and the windings must be protected against elevated temperatures.

### Applications

Installation materials such as junction boxes and distribution boxes, terminal compartments for heaters, storage batteries, transformers, inductive ballasts, electrical motors, squirrel cage induction motors, lighting fixtures.

Cable glands for increased safety are tested according to IEC/EN 60079-7 for the following points:

- mechanical design
- electrical-thermal testing

### 1 Entry threads

Progress® cable glands with entry threads in metric or Pg designs can be used with existing threads or, in the case of drilled through holes, with locknuts.

### 2 High distortion protection

The integrated retaining grooves in the lower part and in the sealing insert ensure protection against twisting.

### 3 Guaranteed sealing capability

Inner contours matched to the sealing insert ensure a targeted deformation of the insert and guarantee a perfect seal.

### Testing standards

IEC 60079-0:2004 / EN 60079-0:2006  
 IEC 60079-7:2006 / EN 60079-7:2007  
 IEC 61241-0:2004 / EN 61241-0:2006

### Marking

II 2G Ex e II  
 Ex td A21 IP68  
 PTB 02 ATEX 1126X  
 IECEx SEV 12.0002X



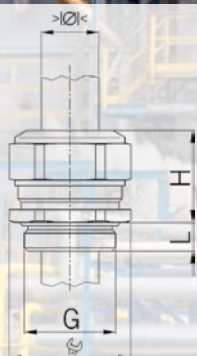

**Designation:** Progress GFK EX  
**Material:** Polyamide glass fibre reinforced  
**Properties:** halogen-free  
**Seal:** TPE / NBR  
 one-piece sealing insert, not overall length insulated  
**Temperature range:** -20°C / +85°C  
**Protection class:** IP 68  
**Test standard:** see page 24  
**Category 2G:** Ex e II  
**Category 2D:** Ex tD A21 IP68  
**Zone:** Gas 1 and 2 / dust 21 and 22  
**Certificate:** EC-type examination certificate PTB 02 ATEX 1126X  
**IECEx Certificate:** IECEx SEV 12.0002X  
**Approvals:**

Entry thread metric

G	>Ø< min mm	>Ø< max mm	 mm	H mm	L mm	i info	Art.-Nr.	
M16x1.5	4.5	6.0	21	26	12	-	EX1571.17.060	50
M16x1.5	6.0	8.0	21	26	12	-	EX1571.17.080	50
M20x1.5	6.0	8.0	27	28	13	-	EX1571.20.080	50
M20x1.5	8.0	11.0	27	28	13	-	EX1571.20.110	50
M25x1.5	9.5	12.5	34	33	13	-	EX1571.25.125	25
M25x1.5	12.5	16.0	34	33	13	-	EX1571.25.160	25
M25x1.5	16.0	19.0	34	33	13	-	EX1571.25.190	25
M25x1.5	19.0	20.5	34	33	13	-	EX1571.25.205	25
M32x1.5	20.0	21.0	41	35	15	-	EX1571.32.210	25
M32x1.5	21.0	22.0	41	35	15	3	EX1571.32.220	25
M32x1.5	22.0	23.0	41	35	15	3	EX1571.32.230	25
M32x1.5	23.0	25.5	41	35	15	-	EX1571.32.255	25
M40x1.5	25.5	27.0	50	40	15	3	EX1571.40.270	10
M40x1.5	27.0	28.5	50	40	15	-	EX1571.40.285	10
M40x1.5	28.5	30.0	50	40	15	3	EX1571.40.300	10
M40x1.5	30.0	33.0	50	40	15	-	EX1571.40.330	10
M50x1.5	33.0	35.0	60	42	16	3	EX1571.50.350	10
M50x1.5	35.0	37.0	60	42	16	-	EX1571.50.370	10
M50x1.5	37.0	39.0	60	42	16	3	EX1571.50.390	10
M50x1.5	39.0	42.0	60	42	16	-	EX1571.50.420	10
M63x1.5	42.0	44.0	75	48	16	3	EX1571.63.440	5
M63x1.5	44.0	46.0	75	48	16	-	EX1571.63.460	5
M63x1.5	46.0	48.0	75	48	16	3	EX1571.63.480	5
M63x1.5	48.0	52.0	75	48	16	-	EX1571.63.520	5

3 = Material sealing insert NBR

Entry thread Pg

G	>Ø< min mm	>Ø< max mm	 mm	H mm	L mm	i info	Art.-Nr.	
Pg 9	4.5	6.0	21	26	12	-	EX1571.09.060	50
Pg 9	6.0	8.0	21	26	12	-	EX1571.09.080	50
Pg 11	4.0	5.5	24	28	12	-	EX1571.11.055	50
Pg 11	5.5	8.5	24	28	12	-	EX1571.11.085	50
Pg 13	6.0	8.0	27	28	13	-	EX1571.13.080	50
Pg 13	8.0	11.0	27	28	13	-	EX1571.13.110	50
Pg 16	6.0	8.0	27	28	13	-	EX1571.16.080	50
Pg 16	8.0	11.0	27	28	13	-	EX1571.16.110	50
Pg 21	9.5	12.5	34	33	13	-	EX1571.21.125	25
Pg 21	12.5	16.0	34	33	13	-	EX1571.21.160	25
Pg 21	16.0	19.0	34	33	13	-	EX1571.21.190	25
Pg 21	19.0	20.5	34	33	13	-	EX1571.21.205	25
Pg 29	19.5	21.0	41	36	13	3	EX1571.29.210	25
Pg 29	21.0	23.0	41	36	13	-	EX1571.29.230	25
Pg 29	23.0	25.0	41	36	13	3	EX1571.29.250	25
Pg 29	25.0	27.5	41	36	13	-	EX1571.29.275	25
Pg 36	27.0	28.5	55	42	16	3	EX1571.36.285	10
Pg 36	28.5	30.5	55	42	16	-	EX1571.36.305	10
Pg 36	30.5	32.5	55	42	16	3	EX1571.36.325	10
Pg 36	32.5	35.0	55	42	16	-	EX1571.36.350	10
Pg 42	33.0	35.0	60	42	16	3	EX1571.42.350	10
Pg 42	35.0	37.0	60	42	16	-	EX1571.42.370	10
Pg 42	37.0	39.0	60	42	16	3	EX1571.42.390	10
Pg 42	39.0	42.0	60	42	16	-	EX1571.42.420	10
Pg 48	41.0	43.0	70	46	16	-	EX1571.48.430	5
Pg 48	43.0	45.0	70	46	16	3	EX1571.48.450	5
Pg 48	45.0	47.0	70	46	16	3	EX1571.48.470	5
Pg 48	47.0	49.0	70	46	16	-	EX1571.48.490	5

3 = Material sealing insert NBR



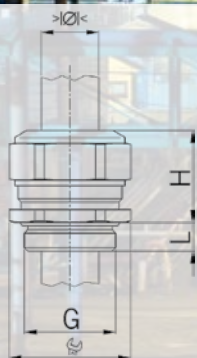

**Designation:** Progress GFK EX  
**Material:** Polyamide glass fibre reinforced  
**Properties:** halogen-free  
**Seal:** TPE / NBR  
 one-piece sealing insert, not overall length insulated  
**Temperature range:** -20°C / +85°C  
**Protection class:** IP 68  
**Test standard:** see page 24  
**Category 2G:** Ex e II  
**Category 2D:** Ex tD A21 IP68  
**Zone:** Gas 1 and 2 / dust 21 and 22  
**Certificate:** EC-type examination certificate PTB 02 ATEX 1126X  
**IECEx Certificate:** IECEx SEV 12.0002X  
**Approvals:**

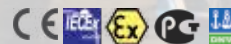

Entry thread metric

G	>Ø< min mm	>Ø< max mm	⌀ mm	H mm	L mm	i info	Art.-Nr.	
M16x1.5	4.5	6.0	21	26	12	-	EX1540.17.060	50
M16x1.5	6.0	8.0	21	26	12	-	EX1540.17.080	50
M20x1.5	6.0	8.0	27	28	13	-	EX1540.20.080	50
M20x1.5	8.0	11.0	27	28	13	-	EX1540.20.110	50
M25x1.5	9.5	12.5	34	33	13	-	EX1540.25.125	25
M25x1.5	12.5	16.0	34	33	13	-	EX1540.25.160	25
M25x1.5	16.0	19.0	34	33	13	-	EX1540.25.190	25
M25x1.5	19.0	20.5	34	33	13	-	EX1540.25.205	25
M32x1.5	20.0	21.0	41	35	15	-	EX1540.32.210	25
M32x1.5	21.0	22.0	41	35	15	3	EX1540.32.220	25
M32x1.5	22.0	23.0	41	35	15	3	EX1540.32.230	25
M32x1.5	23.0	25.5	41	35	15	-	EX1540.32.255	25
M40x1.5	25.5	27.0	50	40	15	3	EX1540.40.270	10
M40x1.5	27.0	28.5	50	40	15	-	EX1540.40.285	10
M40x1.5	28.5	30.0	50	40	15	3	EX1540.40.300	10
M40x1.5	30.0	33.0	50	40	15	-	EX1540.40.330	10
M50x1.5	33.0	35.0	60	42	16	3	EX1540.50.350	10
M50x1.5	35.0	37.0	60	42	16	-	EX1540.50.370	10
M50x1.5	37.0	39.0	60	42	16	3	EX1540.50.390	10
M50x1.5	39.0	42.0	60	42	16	-	EX1540.50.420	10
M63x1.5	42.0	44.0	75	48	16	3	EX1540.63.440	5
M63x1.5	44.0	46.0	75	48	16	-	EX1540.63.460	5
M63x1.5	46.0	48.0	75	48	16	3	EX1540.63.480	5
M63x1.5	48.0	52.0	75	48	16	-	EX1540.63.520	5

3 = Material sealing insert NBR

Entry thread Pg

G	>Ø< min mm	>Ø< max mm	⌀ mm	H mm	L mm	i info	Art.-Nr.	
Pg 9	4.5	6.0	21	26	12	-	EX1540.09.060	50
Pg 9	6.0	8.0	21	26	12	-	EX1540.09.080	50
Pg 11	4.0	5.5	24	28	12	-	EX1540.11.055	50
Pg 11	5.5	8.5	24	28	12	-	EX1540.11.085	50
Pg 13	6.0	8.0	27	28	13	-	EX1540.13.080	50
Pg 13	8.0	11.0	27	28	13	-	EX1540.13.110	50
Pg 16	6.0	8.0	27	28	13	-	EX1540.16.080	50
Pg 16	8.0	11.0	27	28	13	-	EX1540.16.110	50
Pg 21	9.5	12.5	34	33	13	-	EX1540.21.125	25
Pg 21	12.5	16.0	34	33	13	-	EX1540.21.160	25
Pg 21	16.0	19.0	34	33	13	-	EX1540.21.190	25
Pg 21	19.0	20.5	34	33	13	-	EX1540.21.205	25
Pg 29	19.5	21.0	41	36	13	3	EX1540.29.210	25
Pg 29	21.0	23.0	41	36	13	-	EX1540.29.230	25
Pg 29	23.0	25.0	41	36	13	3	EX1540.29.250	25
Pg 29	25.0	27.5	41	36	13	-	EX1540.29.275	25
Pg 36	27.0	28.5	55	42	16	3	EX1540.36.285	10
Pg 36	28.5	30.5	55	42	16	-	EX1540.36.305	10
Pg 36	30.5	32.5	55	42	16	3	EX1540.36.325	10
Pg 36	32.5	35.0	55	42	16	-	EX1540.36.350	10
Pg 42	33.0	35.0	60	42	16	3	EX1540.42.350	10
Pg 42	35.0	37.0	60	42	16	-	EX1540.42.370	10
Pg 42	37.0	39.0	60	42	16	3	EX1540.42.390	10
Pg 42	39.0	42.0	60	42	16	-	EX1540.42.420	10
Pg 48	41.0	43.0	70	46	16	-	EX1540.48.430	5
Pg 48	43.0	45.0	70	46	16	3	EX1540.48.450	5
Pg 48	45.0	47.0	70	46	16	3	EX1540.48.470	5
Pg 48	47.0	49.0	70	46	16	-	EX1540.48.490	5

3 = Material sealing insert NBR

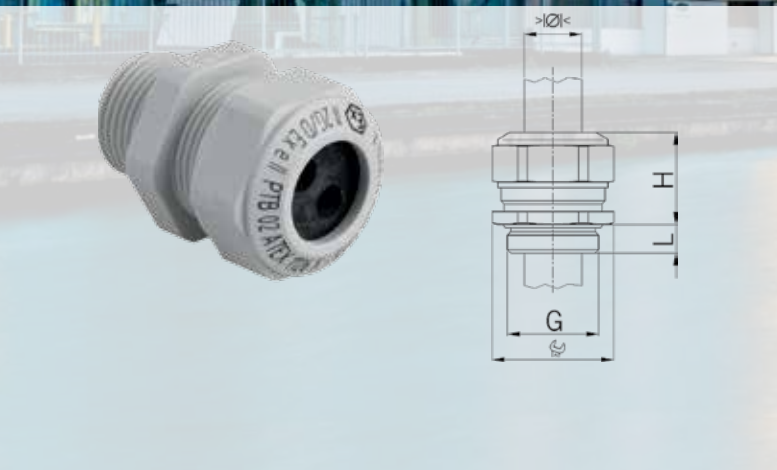

**Designation:** Progress GFK EX  
**Material:** Polyamide glass fibre reinforced  
**Properties:** halogen-free  
**Seal:** TPE / NBR  
 one-piece sealing insert, not overall length insulated  
**Temperature range:** -20°C / +85°C  
**Protection class:** IP 68  
**Test standard:** see page 24  
**Category 2G:** Ex e II  
**Category 2D:** Ex tD A21 IP68  
**Zone:** Gas 1 and 2 / dust 21 and 22  
**Certificate:** EC-type examination certificate PTB 02 ATEX 1126X  
**IECEx Certificate:** IECEx SEV 12.0002X  
**Approvals:**

Entry thread metric

G	>Ø< min mm	>Ø< max mm			H mm	L mm	i info	Art.-Nr.	
M16x1.5	1.0	1.5	4	21	26	12	3	EX1571.17.4.015	50
M16x1.5	2.0	3.0	2	21	26	12	-	EX1571.17.2.030	50
M20x1.5	2.5	3.0	6	27	28	13	-	EX1571.20.6.030	50
M20x1.5	3.5	5.0	2	27	28	13	-	EX1571.20.2.050	50
M25x1.5	5.0	6.0	6	34	33	13	-	EX1571.25.6.060	25
M25x1.5	5.5	7.0	4	34	33	13	-	EX1571.25.4.070	25
M25x1.5	7.5	9.0	3	34	33	13	-	EX1571.25.3.090	25
M25x1.5	8.0	10.0	2	34	33	13	-	EX1571.25.2.100	25
M32x1.5	6.0	7.0	6	41	35	15	-	EX1571.32.6.070	25
M32x1.5	7.5	9.0	4	41	35	15	-	EX1571.32.4.090	25
M40x1.5	8.0	9.0	7	50	40	15	3	EX1571.40.7.090	10
M40x1.5	14.0	15.0	2	50	40	15	3	EX1571.40.2.150	10
M50x1.5	9.0	10.0	4	60	42	16	3	EX1571.50.4.100	10
M63x1.5	11.0	12.0	6	75	48	16	3	EX1571.63.6.120	5
M63x1.5	17.0	18.0	3	75	48	16	3	EX1571.63.3.180	5

3 = Material sealing insert NBR

Entry thread Pg

G	>Ø< min mm	>Ø< max mm			H mm	L mm	i info	Art.-Nr.	
Pg 9	1.0	1.5	4	21	26	12	3	EX1571.09.4.015	50
Pg 9	2.0	3.0	2	21	26	12	-	EX1571.09.2.030	50
Pg 11	3.5	5.0	2	24	28	12	-	EX1571.11.2.050	50
Pg 11	2.0	3.0	3	24	28	12	3	EX1571.11.3.030	50
Pg 13	2.5	4.0	3	27	28	13	3	EX1571.13.3.040	50
Pg 13	3.5	5.0	2	27	28	13	-	EX1571.13.2.050	50
Pg 16	2.5	3.0	6	27	28	13	-	EX1571.16.6.030	50
Pg 16	4.5	6.0	3	27	28	13	-	EX1571.16.3.060	50
Pg 21	5.5	7.0	4	34	33	13	-	EX1571.21.4.070	25
Pg 21	7.5	9.0	3	34	33	13	-	EX1571.21.3.090	25
Pg 29	5.5	6.5	6	41	36	13	3	EX1571.29.6.065	25
Pg 29	8.0	9.0	3	41	36	13	3	EX1571.29.3.090	25
Pg 36	9.0	10.0	4	55	42	16	3	EX1571.36.4.100	10
Pg 36	14.0	15.0	2	55	42	16	3	EX1571.36.2.150	10
Pg 42	9.0	10.0	4	60	42	16	3	EX1571.42.4.100	10
Pg 48	11.0	12.0	6	70	46	16	3	EX1571.48.6.120	5
Pg 48	17.0	18.0	3	70	46	16	3	EX1571.48.3.180	5

3 = Material sealing insert NBR



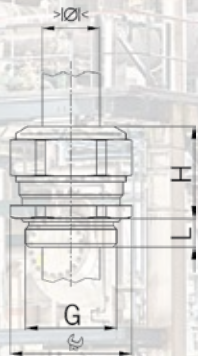

**Designation:** Progress GFK EX  
**Material:** Polyamide glass fibre reinforced  
**Properties:** halogen-free  
**Seal:** TPE / NBR  
 one-piece sealing insert, not overall length insulated  
**Temperature range:** -20°C / +85°C  
**Protection class:** IP 68  
**Test standard:** see page 24  
**Category 2G:** Ex e II  
**Category 2D:** Ex tD A21 IP68  
**Zone:** Gas 1 and 2 / dust 21 and 22  
**Certificate:** EC-type examination certificate PTB 02 ATEX 1126X  
**IECEX Certificate:** IECEX SEV 12.0002X  
**Approvals:**

**Entry thread metric**

G	>Ø< min mm	>Ø< max mm			H mm	L mm	i info	Art.-Nr.	
M16x1.5	1.0	1.5	4	21	26	12	3	EX1540.17.4.015	50
M16x1.5	2.0	3.0	2	21	26	12	-	EX1540.17.2.030	50
M20x1.5	2.5	3.0	6	27	28	13	-	EX1540.20.6.030	50
M20x1.5	3.5	5.0	2	27	28	13	-	EX1540.20.2.050	50
M25x1.5	5.0	6.0	6	34	33	13	-	EX1540.25.6.060	25
M25x1.5	5.0	7.0	4	34	33	13	-	EX1540.25.4.070	25
M25x1.5	7.5	9.0	3	34	33	13	-	EX1540.25.3.090	25
M25x1.5	8.0	10.0	2	34	33	13	-	EX1540.25.2.100	25
M32x1.5	6.0	7.0	6	41	33	13	-	EX1540.32.6.070	25
M32x1.5	7.5	9.0	4	41	35	15	-	EX1540.32.4.090	25
M40x1.5	8.0	9.0	7	50	40	15	3	EX1540.40.7.090	10
M40x1.5	14.0	15.0	2	50	40	15	3	EX1540.40.2.150	10
M50x1.5	9.0	10.0	4	60	42	16	3	EX1540.50.4.100	10
M63x1.5	11.0	12.0	6	75	48	16	3	EX1540.63.6.120	5
M63x1.5	17.0	18.0	3	75	48	16	3	EX1540.63.3.180	5

3 = Material sealing insert NBR

**Entry thread Pg**

G	>Ø< min mm	>Ø< max mm			H mm	L mm	i info	Art.-Nr.	
Pg 9	1.0	1.5	4	21	26	12	3	EX1540.09.4.015	50
Pg 9	2.0	3.0	2	21	26	12	-	EX1540.09.2.030	50
Pg 11	2.0	3.0	3	24	28	12	3	EX1540.11.3.030	50
Pg 11	3.5	5.0	2	24	28	12	-	EX1540.11.2.050	50
Pg 13	2.5	4.0	3	27	28	13	3	EX1540.13.3.040	50
Pg 13	3.5	5.0	2	27	28	13	-	EX1540.13.2.050	50
Pg 16	2.5	3.0	6	27	28	13	-	EX1540.16.6.030	50
Pg 16	4.5	6.0	3	27	28	13	-	EX1540.16.3.060	50
Pg 21	5.5	7.0	4	34	33	13	-	EX1540.21.4.070	25
Pg 21	7.5	9.0	3	34	33	13	-	EX1540.21.3.090	25
Pg 29	5.5	6.5	6	41	36	13	3	EX1540.29.6.065	25
Pg 29	8.0	9.0	3	41	36	13	3	EX1540.29.3.090	25
Pg 36	14.0	15.0	2	55	42	16	3	EX1540.36.2.150	10
Pg 36	9.0	10.0	4	55	42	16	3	EX1540.36.4.100	10
Pg 42	9.0	10.0	4	60	42	16	3	EX1540.42.4.100	10
Pg 48	11.0	12.0	6	70	46	16	3	EX1540.48.6.120	5
Pg 48	17.0	18.0	3	70	46	16	3	EX1540.48.3.180	5

3 = Material sealing insert NBR

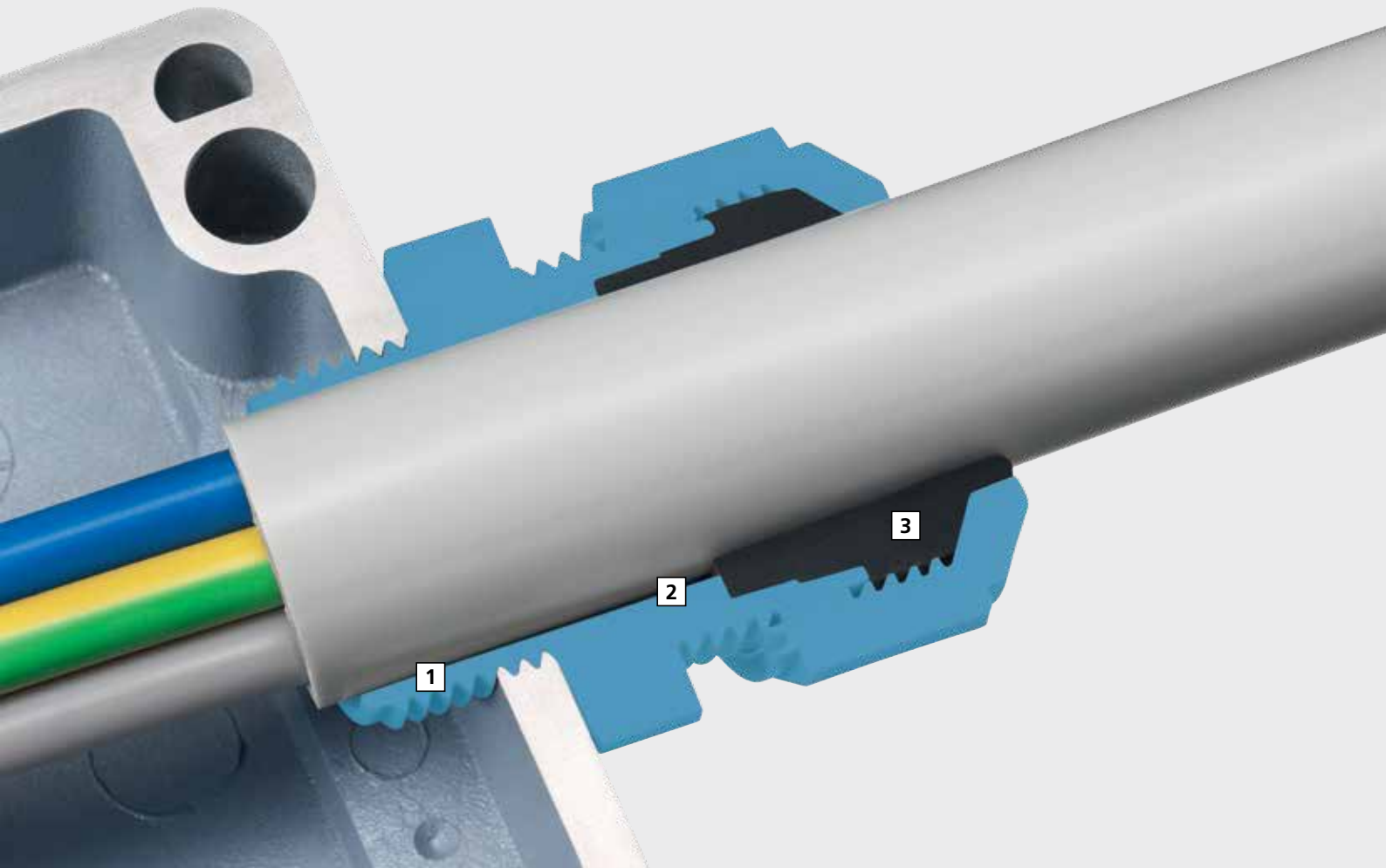

# Intrinsic safety Ex i II

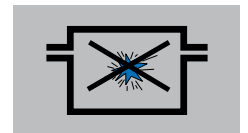

## Principle

A type of ignition protection in which the equipment contains intrinsically safe electrical circuits. An electrical circuit is intrinsically safe when neither a spark nor a thermal effect can cause the ignition of a given explosive atmosphere. The conditions for undisturbed operation and certain error conditions are established in this standard.

Different requirements apply for areas with combustible dust:

- Additional housing in Protection Class IP 6X if dust deposits can become a problem.
- The electrical circuit must be designed for at least Explosion Group IIB.

## Important design parameters

- Selection of certain components for electrical and electronic circuits.
- Reduction of the allowable loading of the components compared to normal industrial applications with regard to
  - voltage because of electrical stability
  - current with respect to heating
- The voltage and current values, including a safety factor, are continually limited to such a low level that it is certain that excessive temperatures cannot arise, while sparks and electric arcs during interruptions or short circuits have so little energy that they are unable to ignite an explosive atmosphere.

## Applications

Measurement, monitoring and information systems and equipment, sensors based on physical, chemical or mechanical principles and with limited power, and actuators based on optical, acoustic and to a limited extent also on mechanical principles.

AGRO cable glands are tested for increased safety, and through the marking with the blue housing they may also be used within intrinsically safe areas i II according to IEC / EN 60079-11

- mechanical design
- electrical-thermal testing

## 1 Entry threads

Progress® cable glands with entry threads in metric or Pg designs can be used with existing threads or, in the case of drilled through holes, with locknuts.

## 2 High distortion protection

The integrated retaining grooves in the lower part and in the sealing insert ensure protection against twisting.

## 3 Guaranteed sealing capability

Inner contours matched to the sealing insert ensure a targeted deformation of the insert and guarantee a perfect seal.

## Testing standards

IEC 60079-0:2004 / EN 60079-0:2006  
 IEC 60079-7:2006 / EN 60079-7:2007  
 IEC 60079-11:2006 / EN 60079-11:2007  
 61241-0:2004 / EN 61241-0:2006

## Marking

II 2G Ex e II  
 Ex td A21 IP68  
 PTB 02 ATEX 1126X IEC  
 IECEX SEV 12.0002X



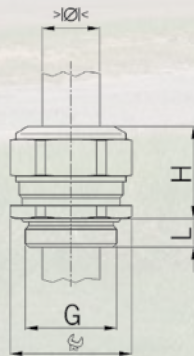

**Designation:** Progress GFK EX  
**Material:** Polyamide glass fibre reinforced  
**Properties:** halogen-free  
**Seal:** TPE / NBR  
 one-piece sealing insert, not overall length insulated  
**Temperature range:** -20°C / +85°C  
**Protection class:** IP 68  
**Test standard:** see page 29  
**Category 2G:** Ex e II / Ex i II  
**Category 2D:** Ex tD A21 IP68  
**Zone:** Gas 1 and 2 / dust 21 and 22  
**Certificate:** EC-type examination certificate PTB 02 ATEX 1126X  
**IECEX Certificate:** IECEX SEV 12.0002X  
**Approvals:**



Entry thread metric

G	>Ø< min mm	>Ø< max mm	mm	H mm	L mm	i info	Art.-Nr.	
M16x1.5	4.5	6.0	21	26	12	-	EX1530.17.060	50
M16x1.5	6.0	8.0	21	26	12	-	EX1530.17.080	50
M20x1.5	6.0	8.0	27	28	13	-	EX1530.20.080	50
M20x1.5	8.0	11.0	27	28	13	-	EX1530.20.110	50
M25x1.5	9.5	12.5	34	33	13	-	EX1530.25.125	25
M25x1.5	12.5	16.0	34	33	13	-	EX1530.25.160	25
M25x1.5	16.0	19.0	34	33	13	-	EX1530.25.190	25
M25x1.5	19.0	20.5	34	33	13	-	EX1530.25.205	25
M32x1.5	20.0	21.0	41	35	15	-	EX1530.32.210	25
M32x1.5	21.0	22.0	41	35	15	3	EX1530.32.220	25
M32x1.5	22.0	23.0	41	35	15	3	EX1530.32.230	25
M32x1.5	23.0	25.5	41	35	15	-	EX1530.32.255	25
M40x1.5	25.5	27.0	50	40	15	3	EX1530.40.270	10
M40x1.5	27.0	28.5	50	40	15	-	EX1530.40.285	10
M40x1.5	28.5	30.0	50	40	15	3	EX1530.40.300	10
M40x1.5	30.0	33.0	50	40	15	-	EX1530.40.330	10
M50x1.5	33.0	35.0	60	42	16	3	EX1530.50.350	10
M50x1.5	35.0	37.0	60	42	16	-	EX1530.50.370	10
M50x1.5	37.0	39.0	60	42	16	3	EX1530.50.390	10
M50x1.5	39.0	42.0	60	42	16	-	EX1530.50.420	10
M63x1.5	42.0	44.0	75	48	16	3	EX1530.63.440	5
M63x1.5	44.0	46.0	75	48	16	-	EX1530.63.460	5
M63x1.5	46.0	48.0	75	48	16	3	EX1530.63.480	5
M63x1.5	48.0	52.0	75	48	16	-	EX1530.63.520	5









3 = Material sealing insert NBR

Available on request:  
for multiple cables

Entry thread Pg

G	>Ø< min mm	>Ø< max mm	mm	H mm	L mm	i info	Art.-Nr.	
Pg 9	4.5	6.0	21	26	12	-	EX1530.09.060	50
Pg 9	6.0	8.0	21	26	12	-	EX1530.09.080	50
Pg 11	4.0	5.5	24	28	12	-	EX1530.11.055	50
Pg 11	5.5	8.5	24	28	12	-	EX1530.11.085	50
Pg 13	6.0	8.0	27	28	13	-	EX1530.13.080	50
Pg 13	8.0	11.0	27	28	13	-	EX1530.13.110	50
Pg 16	6.0	8.0	27	28	13	-	EX1530.16.080	50
Pg 16	8.0	11.0	27	28	13	-	EX1530.16.110	50
Pg 21	9.5	12.5	34	33	13	-	EX1530.21.125	25
Pg 21	12.5	16.0	34	33	13	-	EX1530.21.160	25
Pg 21	16.0	19.0	34	33	13	-	EX1530.21.190	25
Pg 21	19.0	20.5	34	33	13	-	EX1530.21.205	25
Pg 29	19.5	21.0	41	36	13	3	EX1530.29.210	25
Pg 29	21.0	23.0	41	36	13	-	EX1530.29.230	25
Pg 29	23.0	25.0	41	36	13	3	EX1530.29.250	25
Pg 29	25.0	27.5	41	36	13	-	EX1530.29.275	25
Pg 36	27.0	28.5	55	42	16	3	EX1530.36.285	10
Pg 36	28.5	30.5	55	42	16	-	EX1530.36.305	10
Pg 36	30.5	32.5	55	42	16	3	EX1530.36.325	10
Pg 36	32.5	35.0	55	42	16	-	EX1530.36.350	10
Pg 42	33.0	35.0	60	42	16	3	EX1530.42.350	10
Pg 42	35.0	37.0	60	42	16	-	EX1530.42.370	10
Pg 42	37.0	39.0	60	42	16	3	EX1530.42.390	10
Pg 42	39.0	42.0	60	42	16	-	EX1530.42.420	10
Pg 48	41.0	43.0	70	46	16	-	EX1530.48.430	5
Pg 48	43.0	45.0	70	46	16	3	EX1530.48.450	5
Pg 48	45.0	47.0	70	46	16	3	EX1530.48.470	5
Pg 48	47.0	49.0	70	46	16	-	EX1530.48.490	5

# Accessories for Ex cable glands

 <p><b>Locking screws nickel-plated brass Ex d IIC</b> - with metric entry thread - with Pg entry thread Art. no. 8710.XX</p>	 <p><b>Locking rings nickel-plated brass for cable glands Ex d IIC</b> - with metric entry thread - with Pg entry thread Art. no. 18XX.XX.50</p>	 <p><b>Reduction fittings nickel-plated brass Ex e II</b> - with metric entry thread - with Pg entry thread Art. no. EX3500.XX.XX</p>	 <p><b>Enlarging fittings nickel-plated brass Ex e II</b> - with metric entry thread - with Pg entry thread Art. no. EX3600.XX.XX</p>
 <p><b>Locking screws nickel-plated brass Ex e II</b> - with metric entry thread - with Pg entry thread Art. no. EX87XX.08</p>	 <p><b>Locking screws synthetic Ex e II</b> - with metric entry thread - with Pg entry thread Art. no. 8841.XX.</p>	 <p><b>Locknuts nickel-plated brass/synthetics</b> - with metric entry thread - with Pg entry thread 8300.XX / 82XX (grey) / 82XX.40 (black)</p>	 <p><b>Locking pins synthetic</b> - for Ex conformant closing up of unused drill holes</p>

# Certifications



You can find all certifications in the download area of our website [www.agro.ch](http://www.agro.ch).

You can find our complete product line with all technical details in our catalogue and on the Internet at [www.agro.ch](http://www.agro.ch).



# Systems and solutions for professional cable entry.



**Syntec® cable glands** made of plastic or brass are the optimal solution for your daily installation tasks. The patented, unique lamellar technology always guarantees cable routing with excellent strain relief.



**Progress® cable glands** made of plastic or metal are proven aids for professional cable routing in industrial plants. The excellent compression technology ensures tight seals and strain relief which is exceptionally easy on cables.



**Progress® EMC cable glands** made of brass ensure a low-impedance connection between the braided shield and the metal chassis while maintaining secure cable routing.



**Progress® Ex cable glands** made of plastic or brass ensure secure cable routing even in potentially explosive environments.



**Elbows and flanges** to add changes of direction in switching cabinets and chassis.



**Accessories:** locknuts, reduction fittings, locking screws, ...

## Technical information and advice

Please find additional information about products, system solutions and communication media on our website: [www.agro.ch](http://www.agro.ch)

For additional questions or information our technical staff will be available and would be pleased to talk with you.

AGRO phone: +41(0) 62 889 47 47 | AGRO eMail: [info@agro.ch](mailto:info@agro.ch)



**AGRO AG** | A KAISER COMPANY

Korbackerweg 7 · CH-5502 Hunzenschwil  
Phone +41(0)62 889 47 47 · Fax +41(0)62 889 47 50  
[www.agro.ch](http://www.agro.ch) · [info@agro.ch](mailto:info@agro.ch)

 **AGRO**  
... your quality-connection