

# A Distance Ahead

Distance-Based Photoelectric Sensors

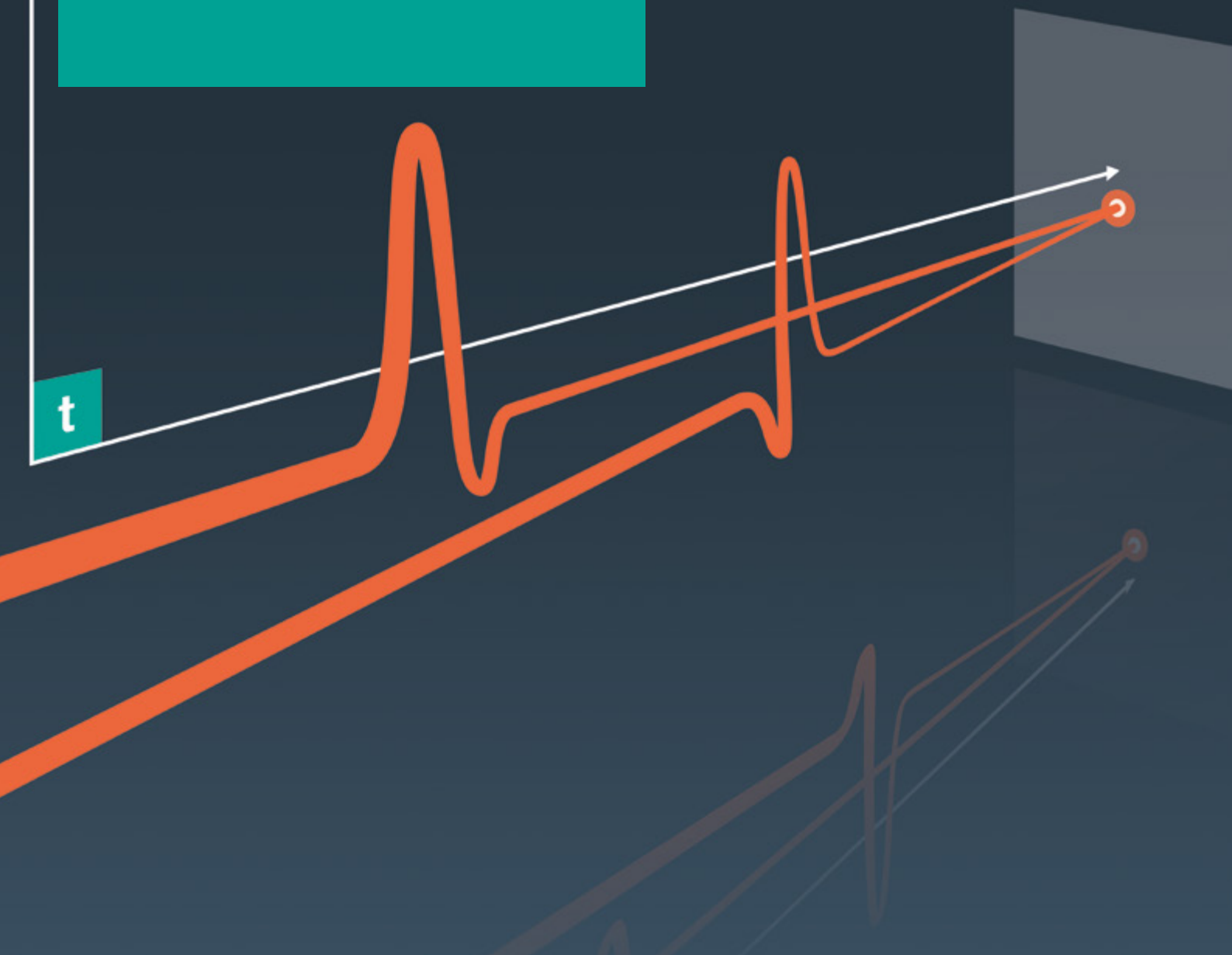

Your automation, our passion.

 **PEPPERL+FUCHS**



# HERMES AWARD

Internationaler  
Technologiepreis der  
HANNOVER MESSE

Pepperl + Fuchs GmbH  
Mannheim

für die  
2012



**AUTOMATION AWARD**  
2012

Sieger-Produkt 2012:

R2000, interaktiver Laserscanner  
Pepperl+Fuchs GmbH, Mannheim

...ATION und unterstützt von Mesago, VDMA und ZVEI



 PEPPERL+FUCHS

# Contents

A Distance Ahead	04
Multi Pixel Technology	06
MLV41 Diffuse Mode Sensor with Measuring Core	10
RL31 Diffuse Mode Sensor with Measuring Core	10
LineRunner Laser Light Sensor	14
Pulse Ranging Technology	16
VDM28 Distance Sensor	20
VDM100 Distance Measurement Device	22
R2000 2-D Laser Scanner	24
R2100 Multi-Ray LED Scanner	30

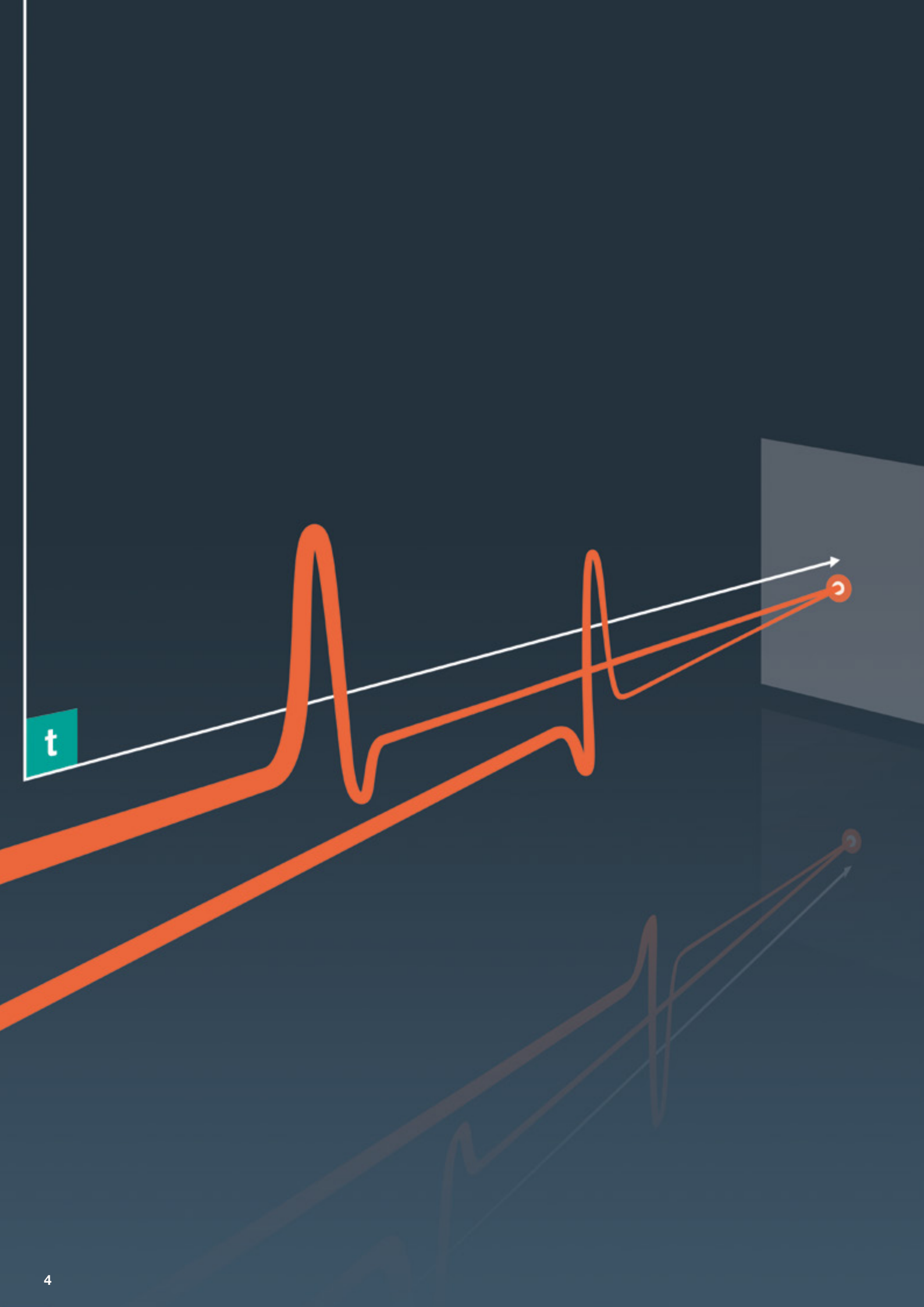

# Our Goal: Providing Innovative Perspectives for World-Class Solutions

Manufacturing plants face a constant battle to remain competitive. Companies streamline production by improving their processes and overall efficiency. Complex application requirements for distance measurement present consistent challenges. To meet these challenges, our technology provides more uptime and higher quality standards combined with zero-defect production.

## A Distance Ahead: Photoelectric Sensors with a Measuring Function – Your Edge for Accuracy

Photoelectric sensors that detect only the absence or presence of an object may not suffice for every application. Distance-based photoelectric sensors address more challenging application requirements by determining both the presence of something, and its position. A new generation of distance-based photoelectric sensors from Pepperl+Fuchs is the first to combine standard photoelectric technology with accurate, state-of-the-art measuring methods.

## Intelligent Functionality for Absolute Accuracy

Distance-based photoelectric sensors from Pepperl+Fuchs bring together two measuring technologies to deliver the highest levels of precision and detection reliability: MPT (Multi Pixel Technology) and PRT (Pulse Ranging Technology). With so much accuracy, you can reliably solve even the most challenging

tasks. This brings you closer than ever to perfect applications, and your crucial edge in the market.

## Engineering Inside: MPT and PRT

MPT uses the triangulation of reflected light common with background suppression sensors to master complex object detection tasks in the near range. No other technology offers greater reliability for applications over short distances.

PRT uses a powerful light source to emit short, high-energy pulses that are reflected by the target object and then recaptured by a light-sensitive receiver. During this process, the emission and reception times are detected with a high degree of precision. From these values, the distance to the target object is calculated using the time delay of the light pulses. If the target object is close, the light propagation time is short. If the object is farther away, the light propagation time is longer. This is your technology of choice for medium and long distances.

# Multi Pixel Technology – Simple Triangulation Measurement for Close- Range Applications

MPT is ideal for measuring ranges of a few inches. The basic principle behind MPT is triangulation. Similar to background suppression (BGS) sensors, light from the sensor's emitter is reflected by an object to the sensor's receiver at varying angles depending on distance.

## Simple and Extremely Accurate

MPT sensors contain a multipixel array receiver that consists of more than two – possibly over one hundred – receiver segments. The triangulation angle – and subsequently where reflected light meets the array – determines if the object is detected. The unique receiver has different sensing modes and configurations for customized sensing.

## Measurable Success at Close Range

MPT combines the benefits of interference-free background suppression, sharply defined sensing and insensitivity to object color, with the measuring capacity of a distance measuring sensor. BGS is the simplest and most cost-effective, but it may not suffice for more complex applications where precision is key. PRT offers top-of-the-line features at medium and long ranges, but you may not need a sensor that powerful. With MPT, you pay for only the features you need to accomplish your close-range tasks.

# The Functional Principle of Multi Pixel Technology – How It Works

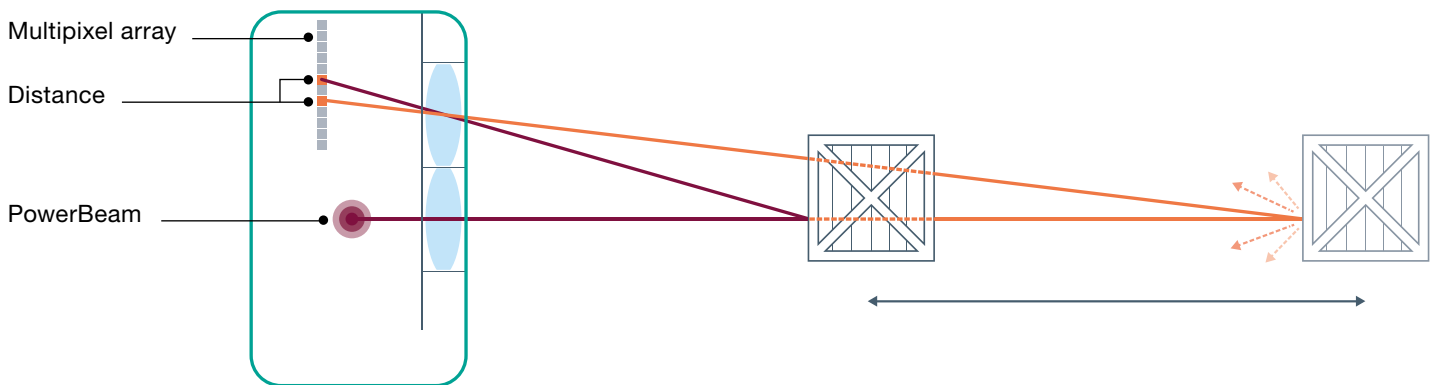

## Triangulation with Measuring Functionality

MPT detects the presence of an object based on its distance from the sensor. Along with the triangulation of reflected light, MPT uses a row of photodiodes called the multipixel array receiver to bridge the gap between the simple differential diodes found in BGS sensors and most higher-level distance measurement technology. Its PowerBeam emitter provides a high-intensity, easily aligned light spot that is reflected by the detected object back to the receiver array. The angle of this reflected light determines where the most intense light contacts the array. Using a microprocessor and appropriate software algorithms, the MPT sensors calculate the object distance based on this data. The sensor's microprocessor and IO-Link capability can be used to customize sensing thresholds and windows for the application.

## Typical Applications

- Well suited to both simple and more complex applications
- Object detection regardless of the surface and texture
- Evaluation of multiple switching thresholds or signaling zones
- Applications in settings with widely varying ambient conditions

# Multi Pixel Technology with 2-D Measuring Capability

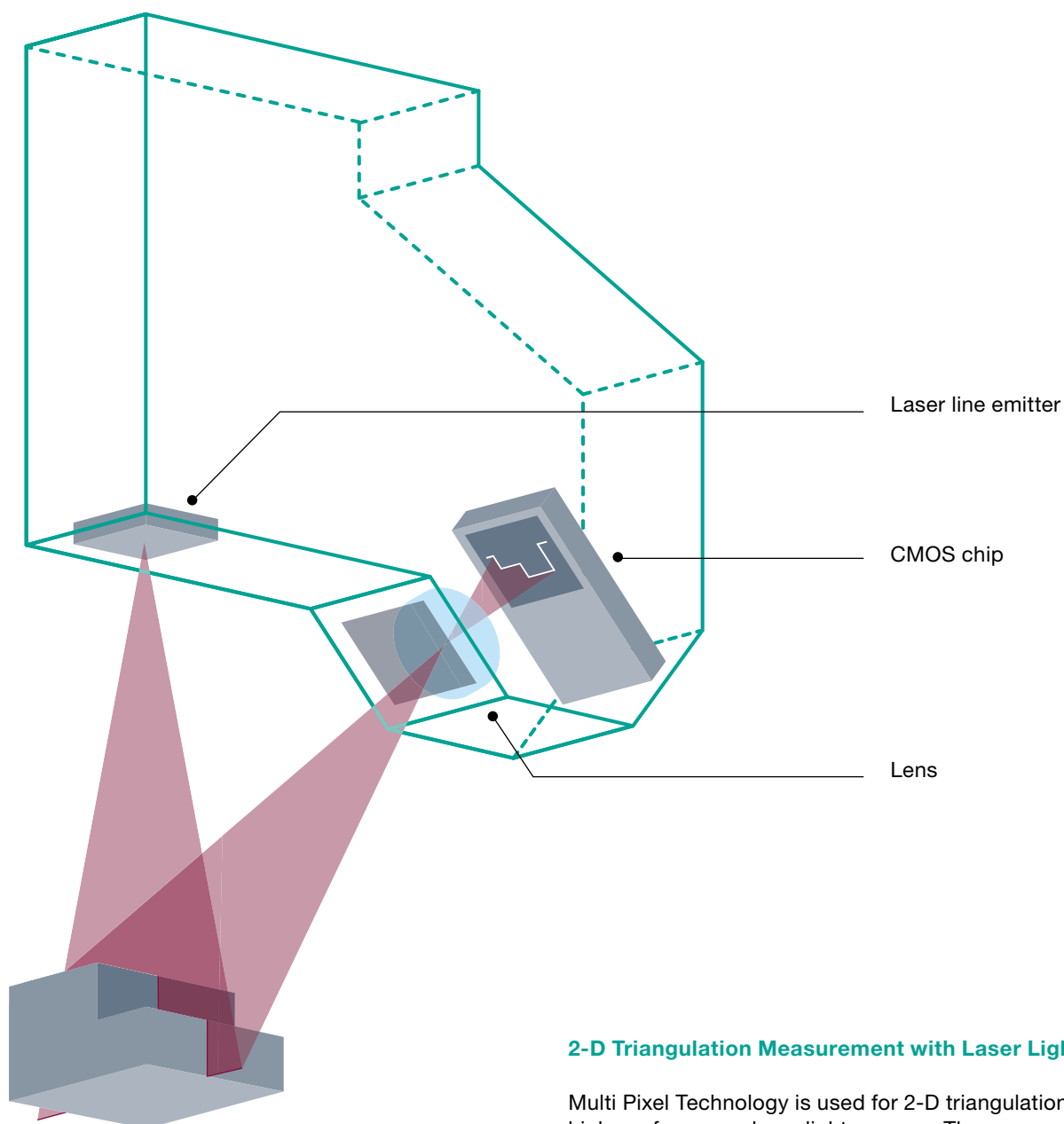



## 2-D Triangulation Measurement with Laser Light

Multi Pixel Technology is used for 2-D triangulation in some high-performance laser light sensors. These sensors have a much more complex structure. Rather than a 1-D multipixel array, these sensors employ a large CMOS chip. This chip is fundamentally analogous to a 2-D multipixel array. In the laser light process, a line projected onto an object is detected at a specific distance and angle. Height and width information is determined using the triangulation principle.



# MPT Sensors for Close-Range Use

			
Series	MLV41	RL31	F225
<b>Use</b>	Switching sensor with several switch points up to 120 mm or up to 500 mm	Switching sensor with several switch points up to 800 mm	Measurement of height and width information
<b>Sensor principle</b>	Diffuse mode sensor with measuring core	Diffuse mode sensor with measuring core	Laser line triangulation
<b>Interface</b>	IO-Link	IO-Link	Ethernet TCP/IP, 100 Mbit/s
<b>Operating modes</b>	<ul style="list-style-type: none"> <li>■ Background suppression</li> <li>■ Background evaluation</li> <li>■ Window mode</li> <li>■ Hysteresis mode</li> </ul>	<ul style="list-style-type: none"> <li>■ Background suppression</li> <li>■ Background evaluation</li> <li>■ Window mode</li> <li>■ Hysteresis mode</li> </ul>	<ul style="list-style-type: none"> <li>■ Single image capture</li> <li>■ Continuous capture</li> <li>■ Master/slave mode</li> </ul>
<b>Detection/measuring range</b>	20 mm to 120 mm or 20 mm to 500 mm, adjustable	50 mm to 800 mm, adjustable	Z = 65 mm to 125 mm X <sub>min</sub> = -15 mm to 15 mm X <sub>max</sub> = -21 mm to 21 mm
<b>Measured value output</b>	No (only as a diagnostic value via IO-Link)	No (only as a diagnostic value via IO-Link)	Digital measured values via Ethernet TCP/IP
<b>Light type</b>	Red LED, PowerBeam	Red LED, PowerBeam	Measuring laser: Infrared laser light, laser class 1 Alignment laser: Red laser light, laser class 1
<b>Diameter of the light spot</b>	4 mm at 100 mm, 25 mm at 500 mm	25 mm at 800 mm	-
<b>Response time</b>	2.5 ms	2.5 ms	2.78 ms ... 11 ms, adjustable
<b>Dimensions W x H x D</b>	31 x 56.5 x 13.6 mm	35 x 62 x 18 mm	108 x 36 x 106 mm

# Choosing the Ideal Sensor for Your Application

Along with reliable object detection and interference suppression, diffuse mode sensors with MPT offer powerful distance measurement capabilities at a lower cost than measuring sensors. Whether you use sensors in a typical industrial environment or in challenging areas with dust, dirt, and corrosion, sensors are available with a variety of housings and configuration options.



MLV41 and RL31

## Intelligent Features for Reliable Detection

Two types of MPT sensors include the MLV41 and RL31 series. These diffuse mode sensors have an IO-Link interface, the same operating modes, a red PowerBeam LED, and a response time of 2.5 ms. A measured value is output only as a diagnostic value via IO-Link. The MLV41 excels when you need to set several switch points. Its adjustable sensing range gives you a closer view than the RL31. Its light spot diameter can be smaller or larger depending on the range. With its corrosion-resistant, dust-tight aluminum housing, this sensor thrives in harsh environments.

The RL31's adjustable sensing range is longer than the MLV41's. Its light spot diameter is larger. Its dual threshold setting, four detection modes in one device, and double to triple the sensing distance of comparable housings let you see and do more.

## Greater Flexibility with IO-Link

Configuring your sensor with IO-Link is an efficient, cost-effective way to customize sensors for their particular task. It allows you to configure more than twelve different options for your specific application, so that just one sensor can meet many different needs. It also provides distance information as a diagnostic value via IO-Link for easy commissioning.

## Light's Best and Brightest: PowerBeam

With an intensely bright emitter LED that significantly improves the visibility of objects, PowerBeam outshines the competition. The high energy density of the light spot allows the reliable detection of dark objects at long distances. The sharp imaging of the light spot enables a high switching accuracy and repeatability, resulting in consistent illumination. PowerBeam works well even with very small objects.

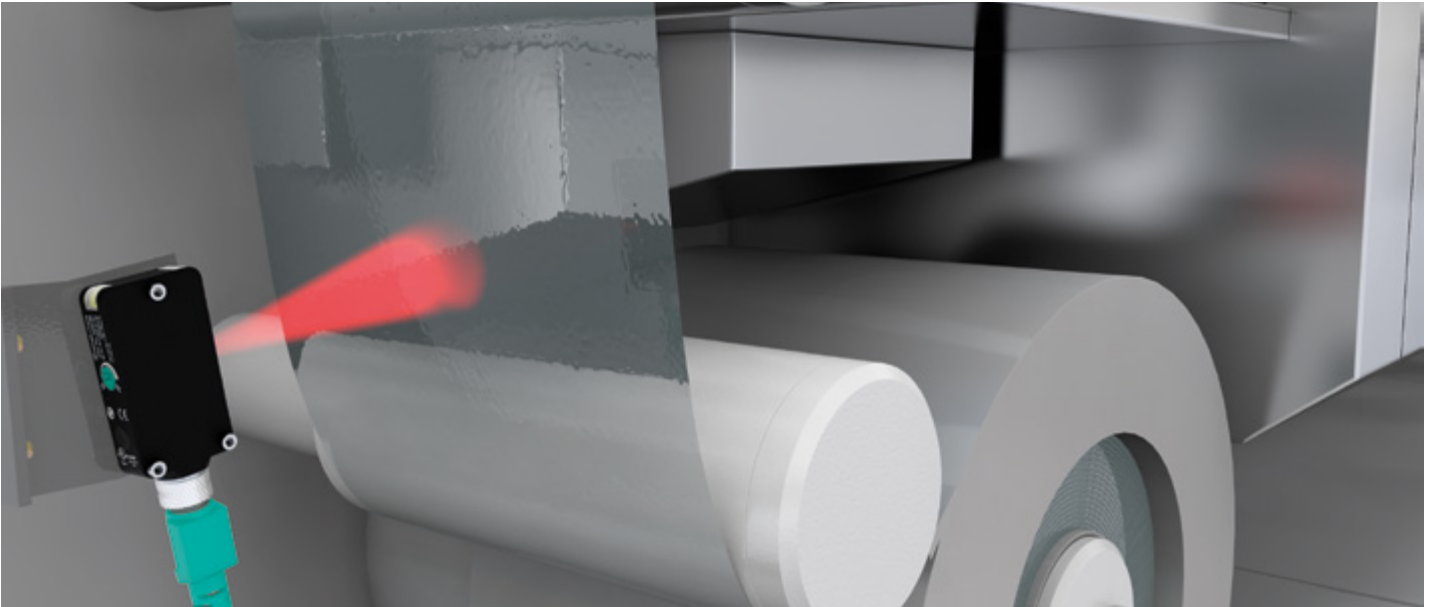

MLV41: Web break monitoring

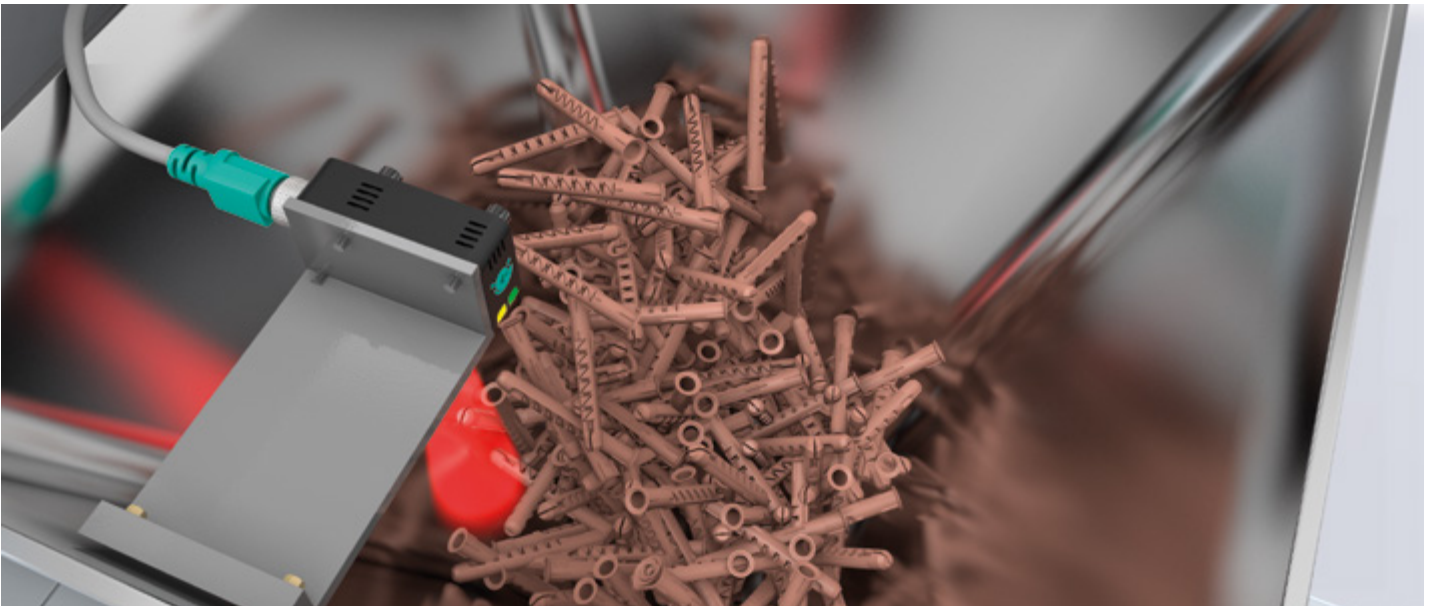

RL31: Fill level monitoring of irregular objects

### Easily Adaptable to Your Application

Diffuse mode sensors with measurement core technology can be used:

- As a sensor with background suppression
- As a sensor with background evaluation
- In window mode with foreground and background suppression
- In hysteresis mode

Configuration is performed via the sensor's IO-Link interface. A corresponding device description file (IO device description – IODD) is available, including the PACTware FDT base application.

### Typical Applications

- Leading edge detection
- Sag control
- Height of stroke detection
- Level control
- Stack height detection
- Collision protection
- Fill level monitoring
- Web break monitoring

# MLV41: High-Quality Aluminum Housing for Extreme Environments



## Highlights

- Corrosion-resistant and dust-tight aluminum housing with Delta Seal coating protects the sensor against corrosive materials
- Reliable detection of all surfaces, regardless of color or texture
- PowerBeam provides a small, defined light spot for maximum visibility and easy alignment
- Custom configuration and diagnostic information is available using IO-Link interface
- High ambient resistance to light and cross-talk protection

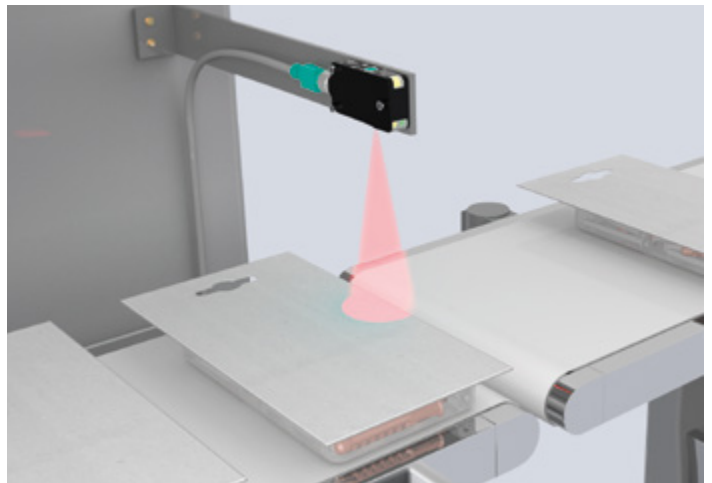

MLV41: Precise edge detection of a closed blister pack

# RL31: Economical Solution for Industrial Applications

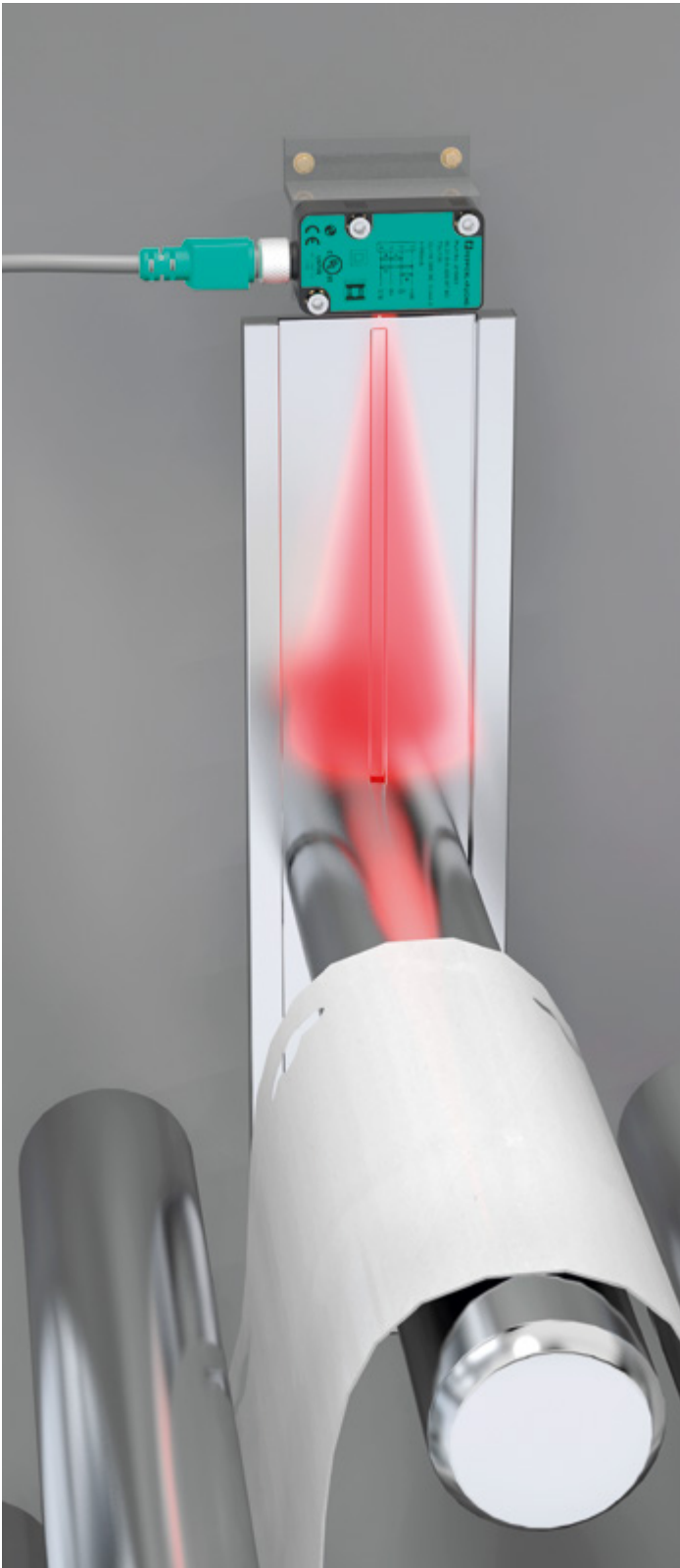

RL31: Height of stroke detection



## Highlights

- Two sensors in one: dual threshold setting activates two independent sensing ranges and outputs
- Integrated measuring core allows four different switching functionalities in one device
- Virtually insensitive to changing object colors
- Extremely visible PowerBeam emitter armed with the brightest and most uniform light spot for optimal alignment and reliable detection
- Automatic data transfer of diagnostic values via IO-Link

# MPT with Laser Technology: A High-Precision Measuring Device for the Third Dimension

For industrial applications requiring profile measurements in harsh environments, the MPT laser light sensor from Pepperl+Fuchs offers high performance, a safe laser class, and an excellent ability to withstand exposure to adverse conditions. A LineRunner sensor projects a laser line across a contour or object. The integrated camera evaluates the resulting image, determines the 2-D position of breaks in the contour/object, and transmits the coordinates.



## Two Pioneering Technologies in One Device

The LineRunner from Pepperl+Fuchs combines Multi Pixel Technology (MPT) and 2-D measurement capability in one sensor. The advantage is that it offers a modern vision solution for high-precision measurement of width and height data in fractions of millimeters on a wide variety of surfaces. It processes even the most problematic color and contrast challenges using a sophisticated exposure time control. The LineRunner has an invisible infrared measuring laser, making it ideal for measuring shiny objects. Compliance with eye-safe laser class 1 does away with the need for additional protection measures for personnel.

In combination with a rotary encoder, it is possible to generate 3-D data. Together with high-performance hardware and software platforms, LineRunner enables implementation of innovative and modular solutions in the areas of automation, sizing, and tolerance verification. Different operating modes allow optimum adjustment for each machine or plant. A Fast Ethernet interface is used for the data transfer of measurement results, calibrations, control commands, and firmware updates.

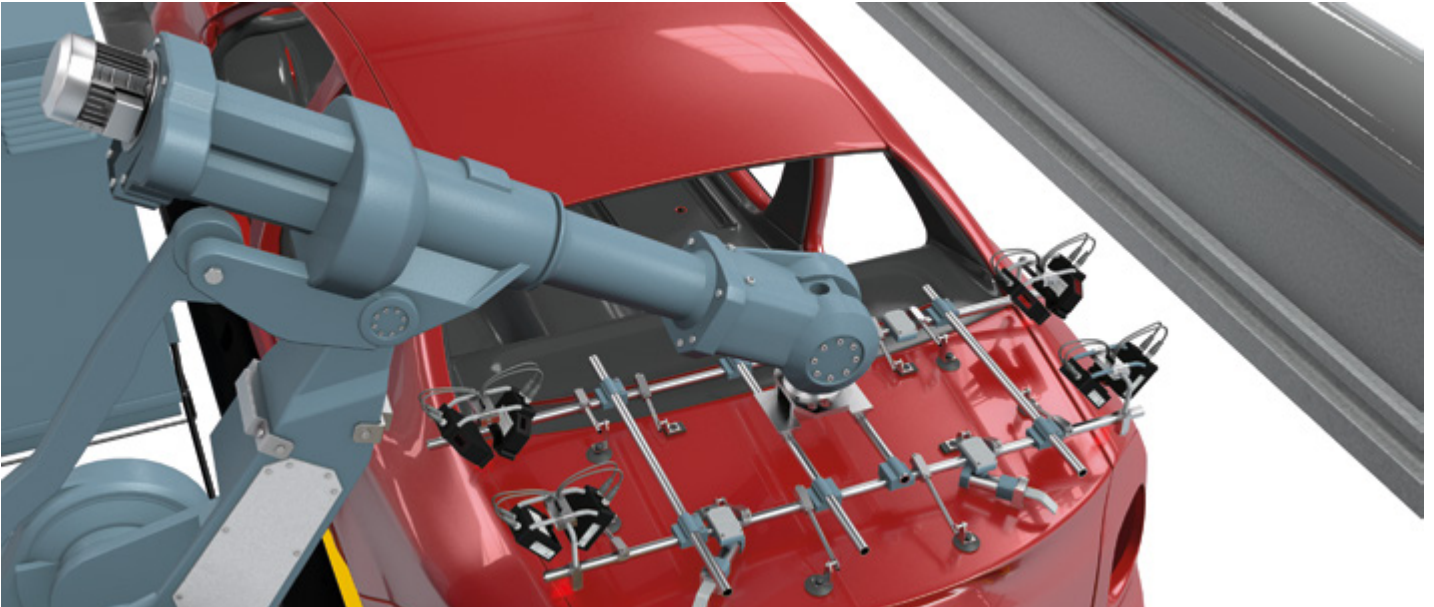

Gap control during the fitting of a trunk lid

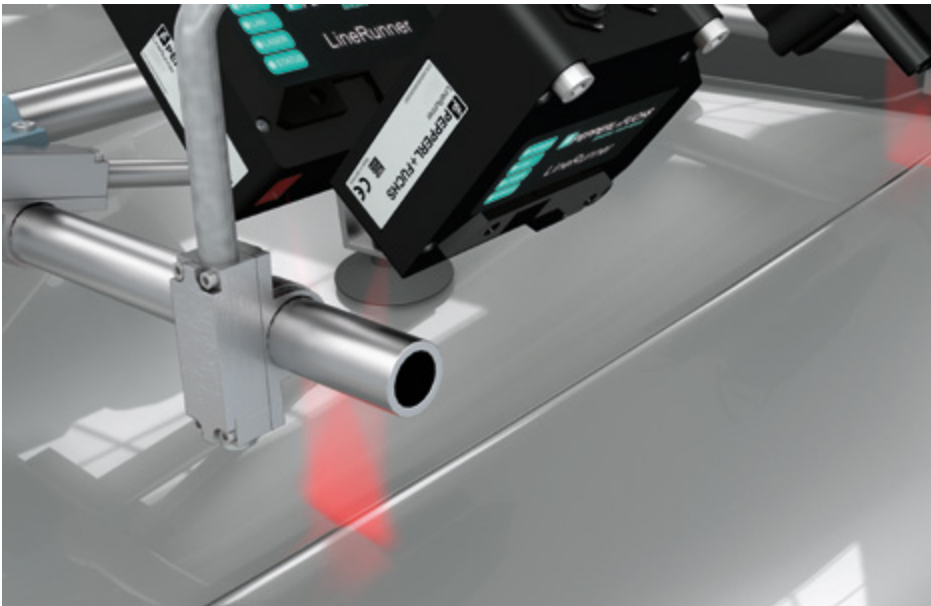

Double-head operation for gap control



LineRunner for path correction

### Typical Applications

- General inspection tasks
- Automation of assembly processes
- Sealing lip or bead size measurement
- High-precision width and height checks
- Path correction for robots
- Edge or gap measurement
- Tolerance checks
- Checking components on PCBs
- High-precision profile measurements (shape measurement and monitoring)

### Highlights

- Reliable measurement of an object's height and width
- Fast and secure measurement on various surfaces with sophisticated exposure control
- Eye-safe with infrared laser and Class 1 laser protection
- Trouble-free, side-by-side operation in special master/slave mode

# Pulse Ranging Technology – Success at the Speed of Light for Long-Range Applications

PRT is ideal for measuring ranges from 0.2 m up to an impressive 300 m. It has the honor of being the most accurate industry-grade distance measuring technology. This direct measurement method ensures reliable and stable measurement results with quick response times, independent of the application environment, so that harsh ambient conditions are not an issue.

## **Pinpoint Repeatability: PRT for Absolute Accuracy**

Measurements that are clear, unambiguous, and repeatable provide the most accurate picture of your application. Whether the distance is near or far, in spite of any constraints imposed by the surroundings or the object being detected, when saving time is crucial – as a state-of-the-art technology, PRT produces results that you can count on every time.

## **Success at the Speed of Light: PRT for Applications over Longer Distances**

PRT harnesses the speed of light in a revolutionary way. Because the speed of light is a constant, it provides a firm basis on which to measure distance. And since this technology

works using light pulses with high energy density, it gives you tremendous advantages, including large detection ranges and the reliable suppression of interference from extraneous light or reflections.

## **Typical Applications**

- Medium to very large detection ranges, widely varying ambient conditions
- Parallel operation of several adjacent sensors
- Accurate object or vehicle positioning
- Measuring the diameter of coils



# Pulse Ranging Technology – How It Works

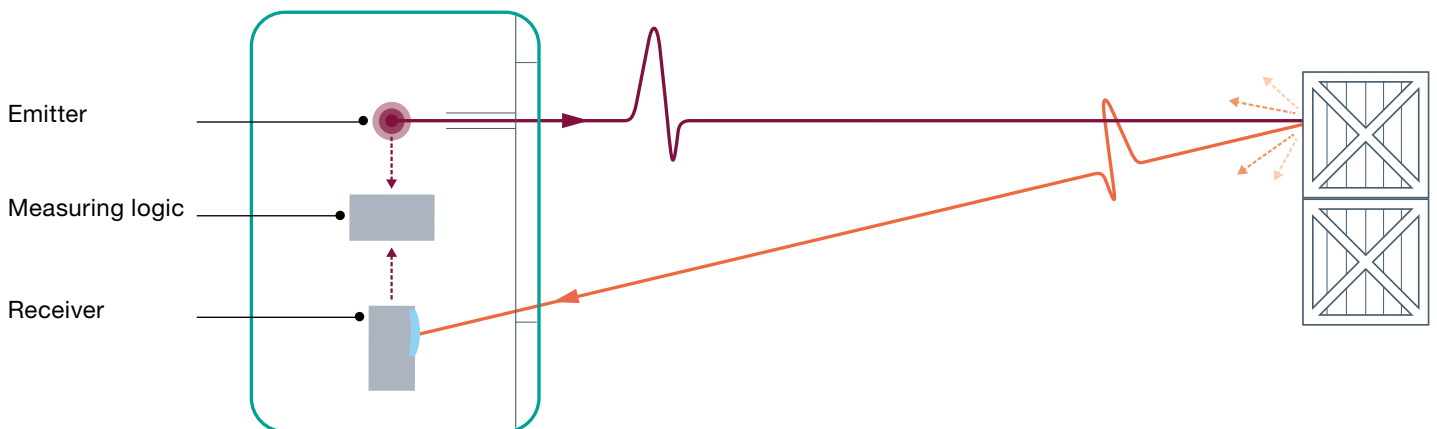

## True Time-of-Flight Technology

Sensors with PRT emit a very short, high-intensity light pulse and calculate object distance based on the speed of light constant and time-of-flight of the reflected light pulse. Unlike other time-of-flight sensors that emit a continuous light beam, PRT sensors emit short pulses of high-intensity light at up to 250,000 times per second. Compared to a continuous source, the energy density of one PRT pulse can be up to 1,000 times greater, allowing stable and highly reliable detection, even at distances of 300 meters.

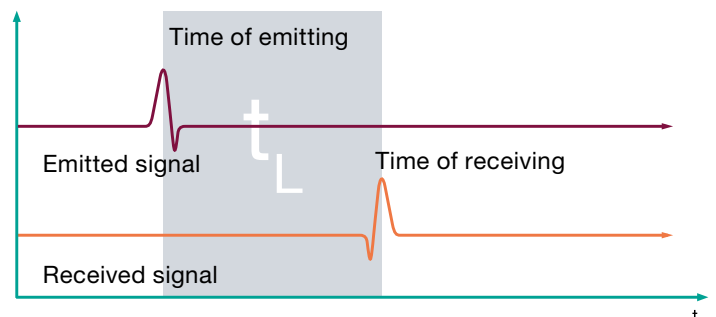

In contrast to triangulation-based sensors, the sensing range of a PRT sensor is not limited by the geometrical layout of the sensor optics. As a result, PRT sensors can take advantage of smaller housings while still providing significantly larger sensing ranges.

# PRT Sensors for Medium to Long Distances

							
Series	VDM28		VDM100	R2000 UHD	R2000 HD	R2000 Detection	R2100
Use	Switching sensor	Measuring sensor	Measuring sensor for accurate positioning to the millimeter	Measuring sensor for accurate position detection	Measuring sensor for accurate object profiling	Switching sensor for detection tasks	Measuring sensor with 88° scanning angle
Interface	-	IO-Link	RS-422, SSI, PROFIBUS, INTERBUS, EtherNet/IP	Ethernet TCP/IP, UDP, 100 Mbit/s	Ethernet TCP/IP, UDP, 100 Mbit/s	Ethernet TCP/IP for configuration	RS-232, CAN bus
Detection/measuring range	8 m/15 m to object/50 m to reflector	8 m/15 m to object/50 m to reflector	50 m/150 m/300 m	10 m to object/60 m to reflector; 30 m to object/100 m to reflector (IR)	30 m to object/30 m to reflector (IR)	10 m to object/30 m to reflector; 30 m to object/30 m to reflector (IR)	0.2 ... 8 m
Repeatability	< 5 mm	< 5 mm	< 0.5 mm	< 12 mm	< 12 mm	< 12 mm	< 25 mm
Resolution	1 mm	1 mm	0.1 mm, adjustable	1 mm	1 mm	1 mm	1 mm
Measured value output	None	Analog value 4 to 20 mA/digital measured value	Digital measurement value	Digital measurement value	Digital measurement value	None	11 digital measuring values
Light type	Red laser light/infrared laser light	Red laser light/infrared laser light	Measuring laser: Infrared laser Alignment laser: Red laser	Red laser light/infrared (IR) laser light	Infrared (IR) laser light	Red laser light/infrared (IR) laser light	Infrared, LED
Diameter of the light spot	< 10 mm at 8 m < 50 mm at 50 m	< 10 mm at 8 m < 50 mm at 50 m	< 35 cm at 150 m < 70 cm at 300 m	< 15 mm at 10 m; 25 mm x 105 mm at 10 m (IR)	25 mm x 105 mm at 10 m (IR)	< 15 mm at 10 m; 25 mm x 105 mm at 10 m (IR)	550 mm at 4 m
Signal output	Push-pull	Push-pull	2x PNP inputs/outputs	-	-	4x push-pull inputs/outputs (selectable)	-
Dimensions W x H x D	25.8 x 88 x 54.3 mm	25.8 x 88 x 54.3 mm	170 x 100 x 140 mm	106 x 116.5 x 106 mm	106 x 116.5 x 106 mm	106 x 116.5 x 106 mm	157 x 81 x 45 mm

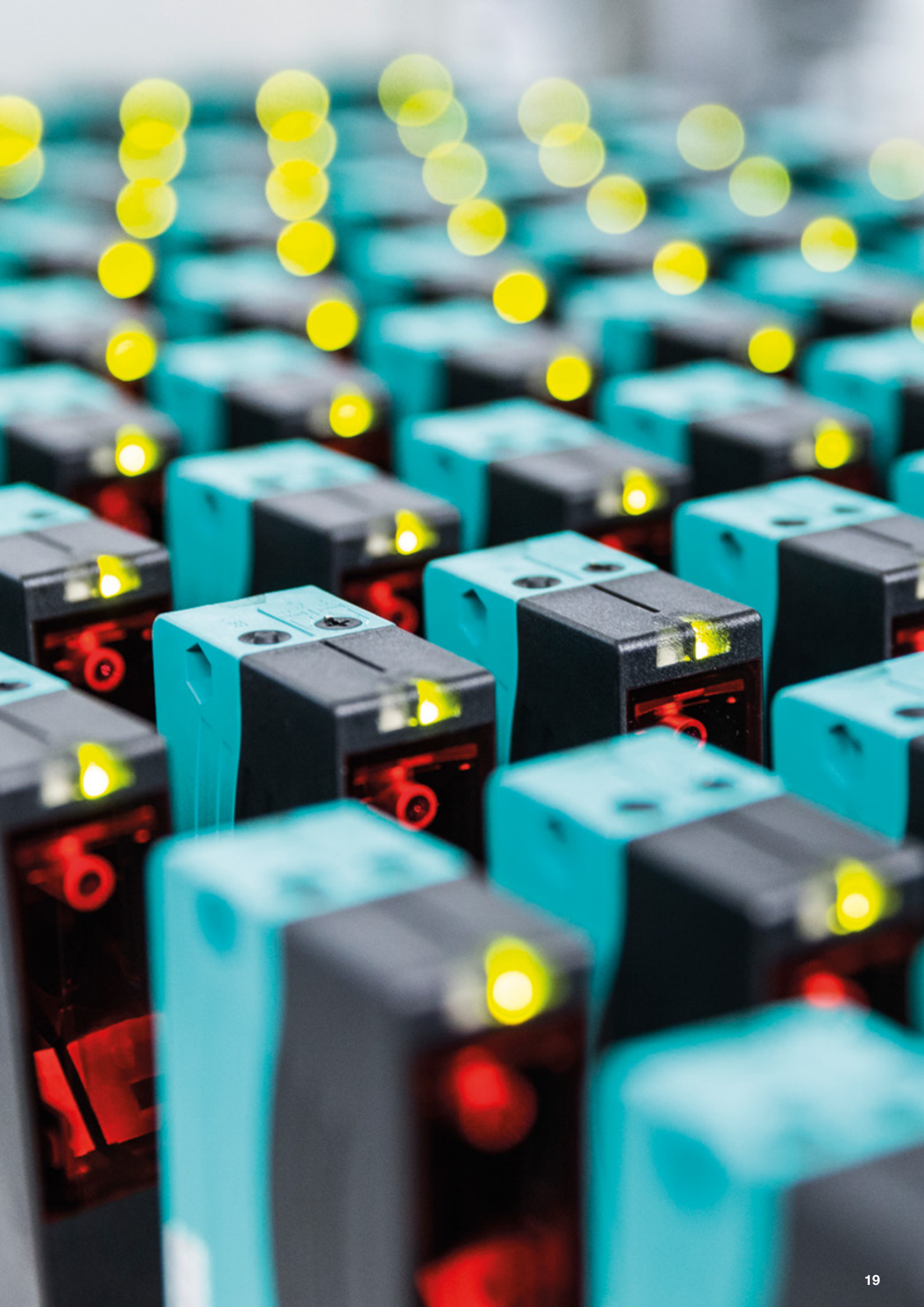

# Universal Appeal: High-Performance Technology for a Wide Range of Applications

Compact and versatile, the VDM28 distance sensor uses PRT, which makes it a performance leader in the market for all comparable devices. The small, visible red light spot from the eye-safe Class 1 or Class 2 laser enables easy alignment and detection of targets regardless of ambient conditions, such as color or surface quality.



## Simple Adjustments for Simpler Applications

Compact and versatile, the VDM28 distance sensor uses PRT, which makes it a performance leader in the market for all comparable devices. The small, visible red light spot from the eye-safe Class 1 or Class 2 laser enables easy alignment and detection of targets regardless of ambient conditions, such as color or surface quality.

## IO-Link Interface for More Complex Applications

In its basic versions, the VDM28 distance measurement device is equipped with either two discrete outputs, each with two switch points, or with one discrete output and one analog output. The functionalities of the device fully cover those of a photoelectric sensor with background suppression – but with an extremely long range. The intuitive teach-in of switch points

via rotary switch and push button makes it easy to adjust for any application task.

Detection modes for the VDM28 include distance measurement, background suppression, foreground suppression, window detection, and window suppression.

## Different Combinations for Different Versions

Distance sensors of the VDM28 series are available in the following versions:

- Measuring/switching sensor
- Diffuse mode/retroreflective mode
- Infrared light/red light
- Laser class 1/laser class 2
- Analog output/IO-Link interface/switching outputs

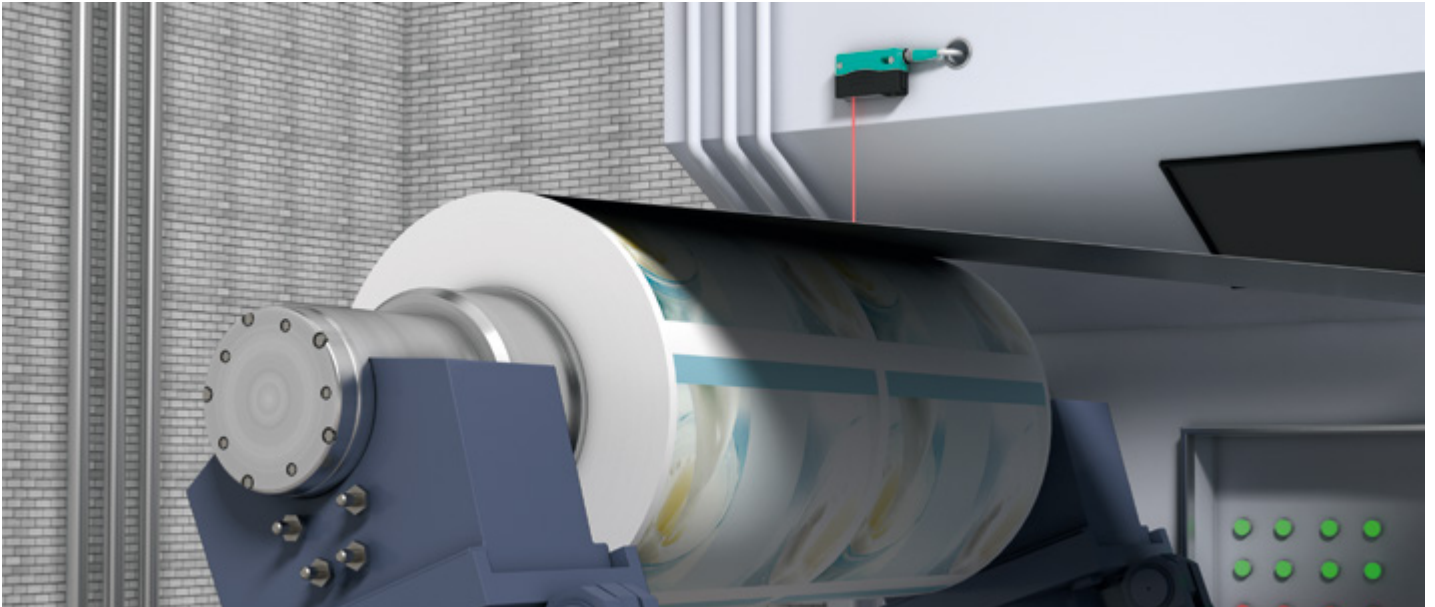

Coil and roll thickness measuring

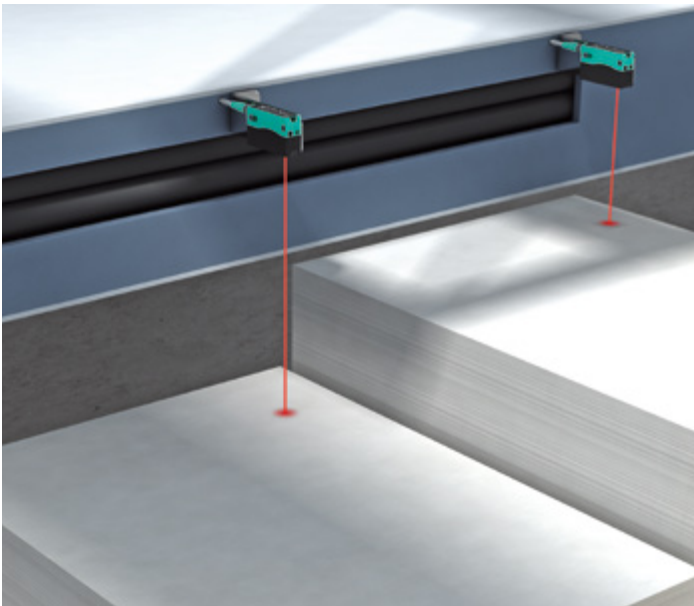

Stack height control

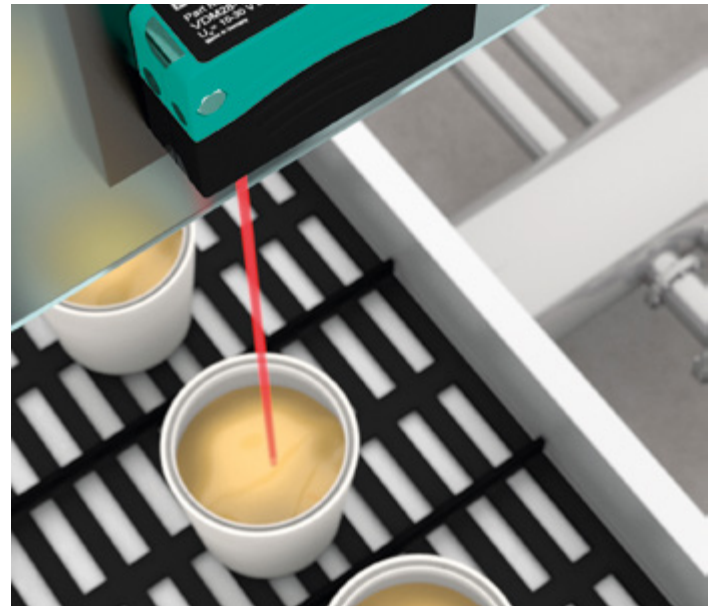

Fill level monitoring

### Typical Applications

- Fill level monitoring
- Storage retrieval
- Stack height control
- Distance measurement
- Distance monitoring
- Thickness measurement of product

### Highlights

- Dual discrete outputs, available analog output
- High ambient resistance to light and cross-talk protection
- High repeatability regardless of the surface texture
- Suitable for cold environments down to -30 °C
- Eye-safe Class 1 and Class 2 laser

# Ultrafast Measurement That Goes the Distance

Using an infrared measuring laser, the VDM100 is a versatile, high-performance solution for your measuring needs. Noncontact and eye-safe, this modern, robust sensor is ideal for positioning tasks requiring speed and precision. Increase your productivity to your exact specifications.



## Absolute Accuracy Assured

The VDM100 distance measurement device sets new standards with a repeat accuracy of up to 0.5 mm, a resolution of 0.1 mm, and a maximum travel speed of 10 m/s. Users benefit from the significant insensitivity to ambient light and interference immunity with regard to multiple targets, as well as high temperature and long-term stability without drift. For overhead installations, the display and operating elements rotate 180° for improved usability. Other advantages include the programmable inputs/outputs and a measuring range of up to 300 m.

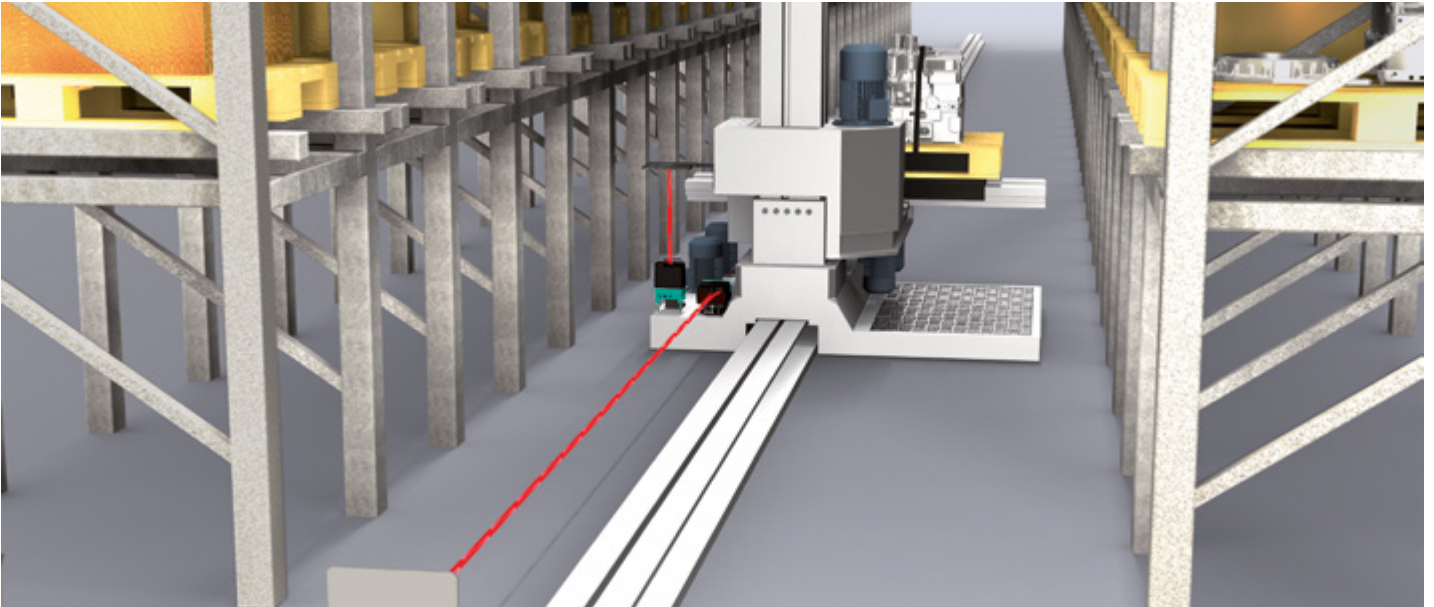

Reliable positioning of a stacker crane in a high-bay warehouse

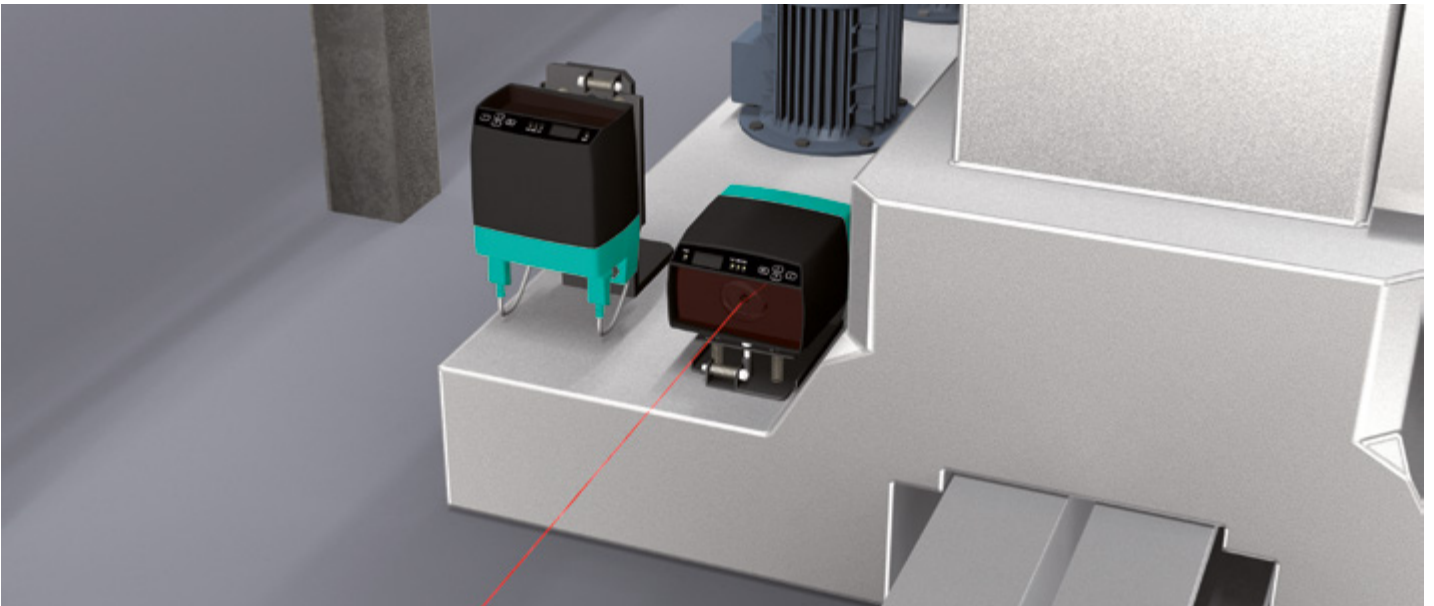

Position determination along the X-axis and the Y-axis

### Typical Applications

- Exact positioning of stacker cranes, gantry cranes, and conveyors
- Safeguarding minimum distances
- Verifying occupancy conditions

### Highlights

- Improved productivity due to high speed, seamless data acquisition
- High resistance to ambient light
- Easy to install with click-clamp mounting bracket
- Easy integration in different environments with a wide variety of interfaces: RS-422, SSI, PROFIBUS, INTERBUS, EtherNet/IP
- Simple 4-push-button programming
- Eye-safe infrared measurement laser (laser class 1)

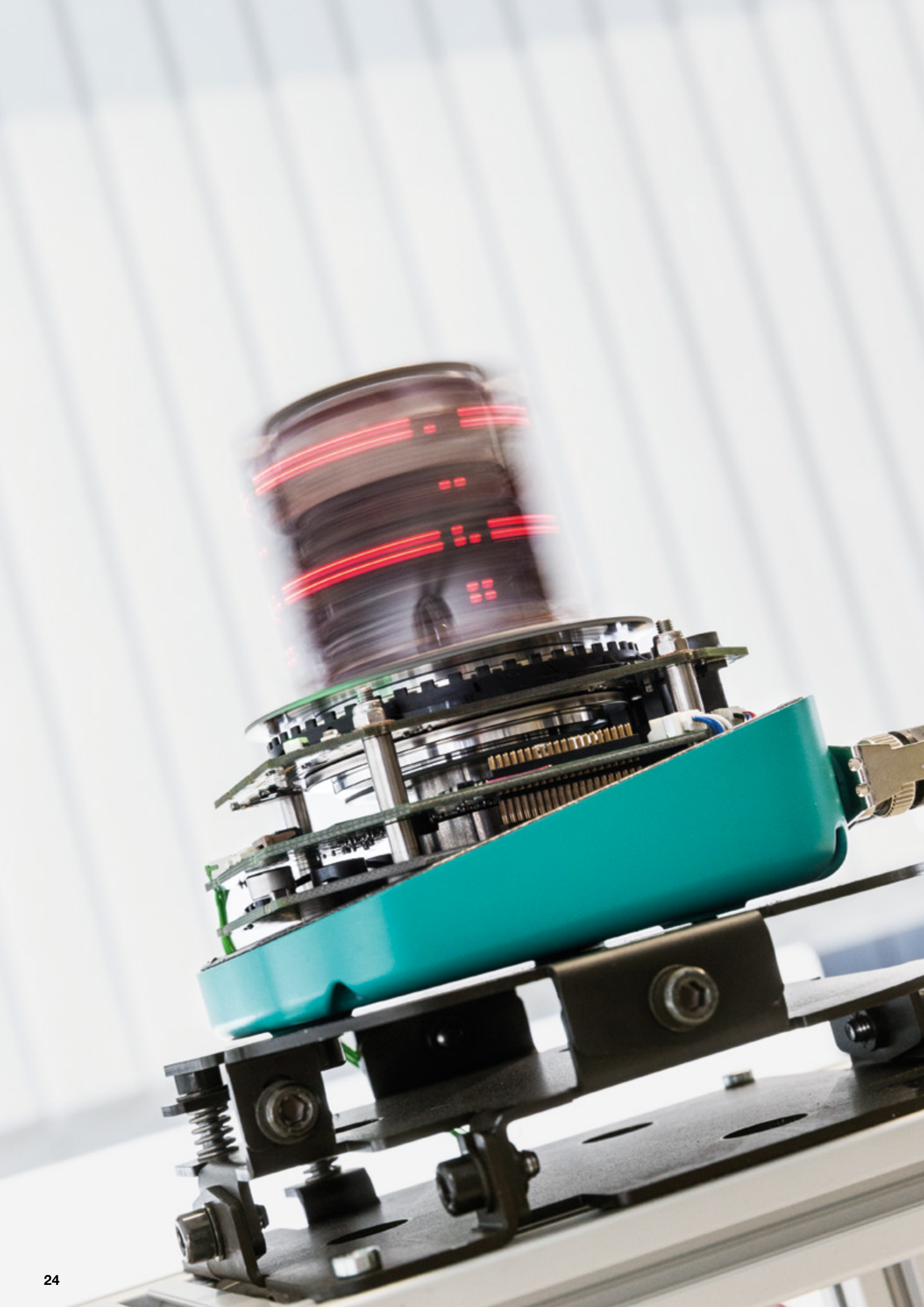



# 2-D Laser Scanner with 360° All-Round Visibility

The innovative R2000 2-D laser scanner is the perfect combination of modern technology and design elements that raises the bar in scanning technology. This opens up a range of interesting new applications for the R2000.



## One Series, Multiple Versions

The R2000 series is capable of extremely accurate measurements at fast scan rates. An interactive display with text and graphical information about the application, combined with simple configuration, make it incredibly user-friendly. And PRT allows reliable and precise measurements in industrial environments. Very small objects are consistently detected, even at long distances.

Several versions of the R2000 are available for your applications. The R2000 UHD is suitable for complex measuring tasks and navigation. The R2000 HD is used for object profiling and robotic applications. The R2000 Detection is an easy-to-use laser scanner for demanding field monitoring applications.

## R2000 Series Highlights

- Pulse Ranging Technology for high precision and reliability
- Sharp, pinpoint light spot allows detection of small objects, reflectors, or edges
- 360° measurement for all-round visibility
- Compact design for simple mechanical integration
- Interactive, wrap-around LED display provides easy-to-see status information

# Excellent Performance: The Intelligent R2000 UHD for Complex Tasks

In addition to exact distance and angle measurement, the R2000 UHD (Ultra High Density) can differentiate between natural objects and reflectors. An accurate time stamp in the measurement data allows precise integration into dynamic measurement tasks.



R2000 UHD provides distance, angular, and signal data for navigation

## R2000 UHD Highlights

- Suitable for high-speed applications due to a rapid scan rate of 50 Hz
- Best angular resolution on the market of  $0.014^\circ$  ensures extremely accurate navigation and positioning
- Extended-range version with infrared laser provides up to 100 m range

## R2000 UHD

The R2000 UHD combines speed with high resolution. It offers an unmatched angular resolution down to  $0.014^\circ$  and a fast scan rate of 50 revolutions per second. This provides 250,000 scan points per second, making it ideal for high-speed applications even at long distances.

R2000 UHD is available with a visible red laser or infrared laser. The R2000 with infrared laser provides up to 30 m range to natural objects and 100 m range to reflectors.

# Specialized Features: The R2000 HD is Optimized for Object Profiling and Robotics

The measuring sensor R2000 HD (High Density) is the ideal solution for tasks in robotics and excels due to its reliable object profiling.



R2000 HD is optimized for object profiling and robotics

## R2000 HD

The R2000 HD is optimized for applications in the field of robotics. It is available with an infrared laser and provides high-precision contour measurement data up to 30 m to a reflector and natural objects.

With its 360° measurement angle, this 2-D laser scanner meets the requirements of typical robotic applications by providing 84,000 scan points per second and an angular resolution down to 0.043° to ensure precise object profiling.

### R2000 HD Highlights

- Optimized for object profiling and robotic applications
- Angular resolution of 0.043° ensures precise contour measurement and object localization

# For Fast Applications and the Smallest Objects: The R2000 Detection for Demanding Field Monitoring Applications

The R2000 Detection laser scanner offers four user-configurable detection fields. With user-friendly software, each field can be edited and assigned to a specific output. Also, a sharp, pinpoint light spot enables precise detection of small objects and edges.

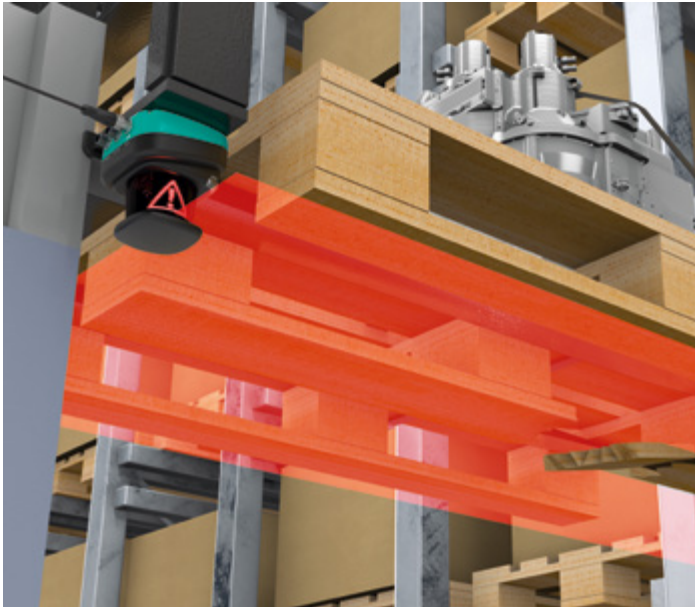

Detection of small overhangs such as damaged pallets

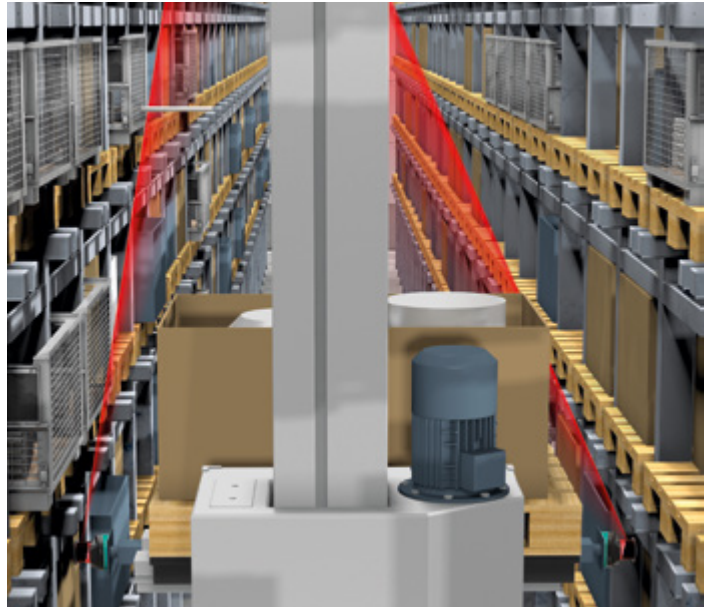

Detection of protrusions or obstacles over large areas

## R2000 Detection

Combining simple configuration with a razor-sharp, 2-D scan plane that enables object detection only a few millimeters above a surface, the R2000 Detection provides an ideal solution for application tasks that include gap control, empty storage bay detection in an ASRS plant, and collision avoidance in AGV and stacker cranes.

R2000 Detection is available with a visible red laser or infrared laser. The R2000 with infrared laser allows you to monitor an area with a radius of up to 30 m to natural objects.

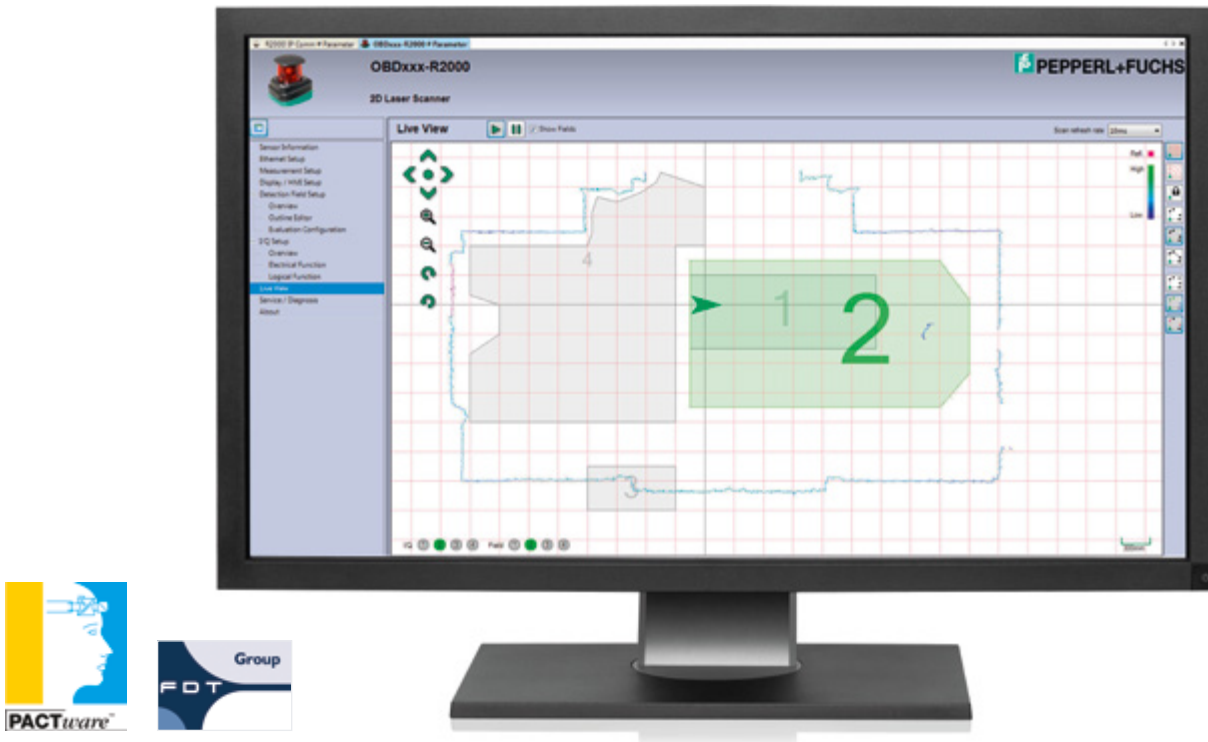

### Simple to Use – Four User-Defined Detection Fields

The four detection fields are quickly and easily defined with the intuitive field editor of the device type manager (DTM). Fields and inputs are linked logically to the outputs and make configuration very simple and user-friendly.

PACTware and R2000 DTM software are free to download at: [www.pepperl-fuchs.com/dtm-r2000](http://www.pepperl-fuchs.com/dtm-r2000)

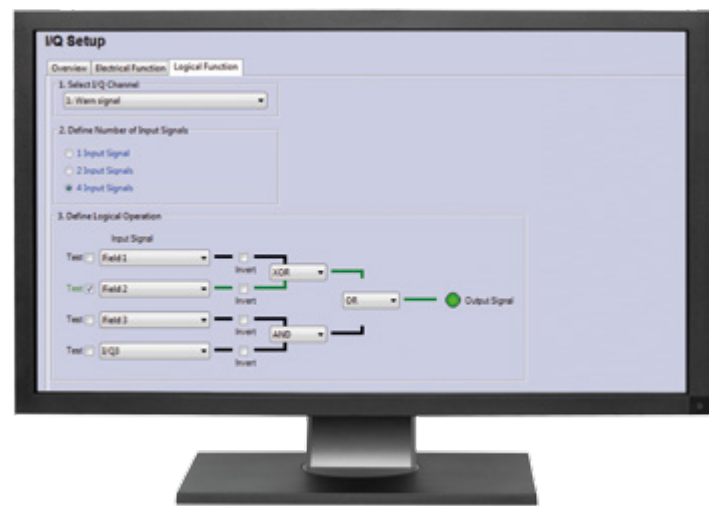

### Typical Applications

- Overhang, gap, and compartment-occupied checks
- Avoidance of collisions for AGVs, suspended conveyor systems, or freely navigating platforms

### R2000 Detection Highlights

- A stable, wobble-free scanning axis guarantees precise monitoring of the scan surface
- Highest angular resolution of any digital I/O scanner on the market – 0.071° – ensures detection of extremely small objects
- Simple handling – four freely configurable detection fields easily link to the digital outputs
- Extended-range version with infrared laser provides up to 30 m range to natural objects

# Sophisticated Design for Maximum Efficiency

The R2100 pushes the realm of possibility one step further by combining our PRT with ultra-IR LEDs and multiray scan. Equipped with these breakthrough technologies, the R2100 becomes an economical solution with exceptional performance, flexibility, and durability.



## Innovative Technologies for Challenging Applications

Demanding tasks require robust sensors. The R2100 is the ideal solution for a multitude of technologically challenging applications in mobile equipment, intralogistics, specialty machines, and system engineering. Unlike most 2-D laser scanners that use a motorized system to rotate a mirror, the R2100 evaluates a 2-D area over 88 degrees by employing multiple emitter elements arranged side by side. This results in a robust, fast, and cost-effective sensor solution.

## For Demanding Applications

The R2100 evaluates objects in two dimensions with multiray scan – evaluating a 2-D area using an array of wide-beam LED emitters. Combining this technology with PRT ensures reliable detection of any surface, regardless of shape or texture. And with no moving parts to break down or wear out

over time, the R2100 delivers the extra durability, ruggedness, and measurement stability that is critical in mobile equipment applications.

## High Response Speeds for Fast Processes

The sophisticated sensor electronics allow the highest response rates. This guarantees very fast process times and maximum efficiency. The R2100 is ideal for automated storage and retrieval (ASRS) tasks in the material handling and logistics industry. Lightning-fast PRT guarantees fast response times for rapid processes.

Eye-safe ultra-IR LEDs and no moving parts result in low power consumption and allow operation over a wide range of temperatures – without the need for additional cooling equipment.

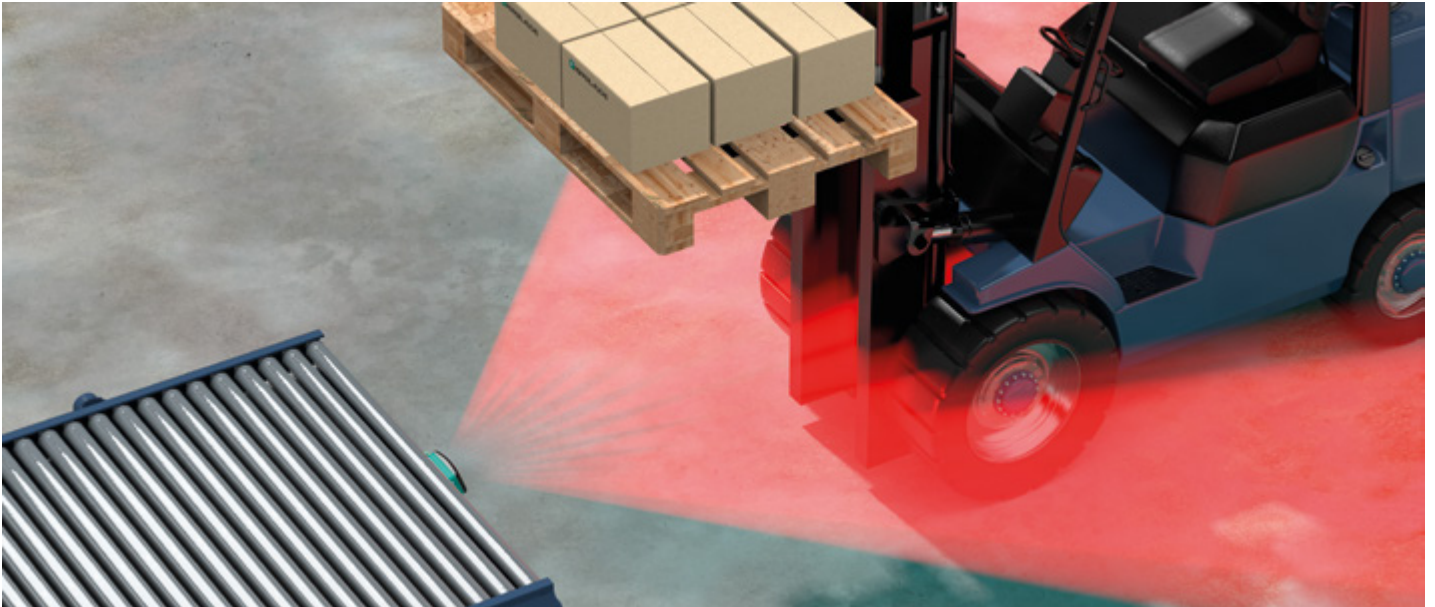

Reliable forklift detection at a transfer station

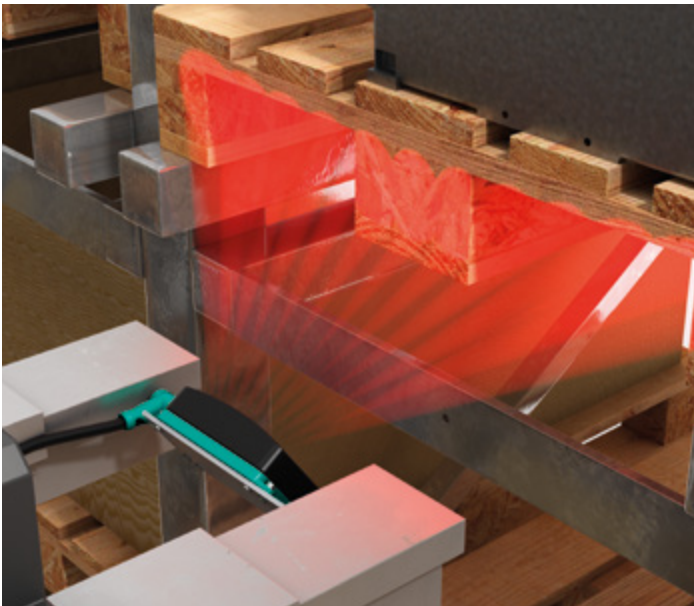

The R2100 detects empty storage bays in an ASRS plant

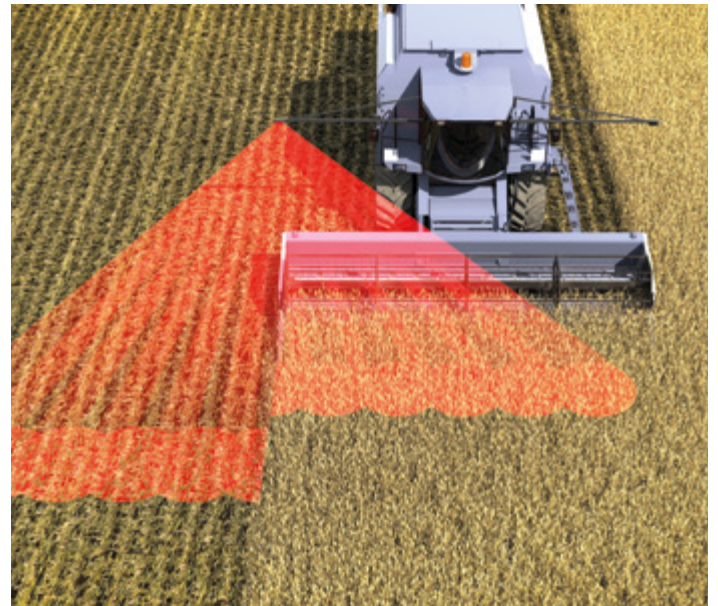

The R2100 ensures precise guidance along the harvesting line

### Typical Applications

- Object detection and classification
- Collision protection
- Vehicle detection
- Empty storage detection

### Highlights

- PRT provides reliable and precise distance measurement information
- Ultra-IR LEDs guarantee powerful performance and a long lifetime
- No moving parts for added durability in difficult application environments
- 2-D measurement with multiray scan
- Multiple wide-beam emitters ensure reliable object detection regardless of surface texture
- Low current consumption reduces energy-related design and operating costs
- Fast response time for rapid processes

# Your automation, our passion.

## Explosion Protection

- Intrinsically Safe Barriers
- Signal Conditioners
- Fieldbus Infrastructure
- Remote I/O Systems
- HART Interface Solutions
- Wireless Solutions
- Level Measurement
- Purge and Pressurization Systems
- Industrial Monitors and HMI Solutions
- Electrical Explosion Protection Equipment
- Solutions for Explosion Protection

## Industrial Sensors

- Proximity Sensors
- Photoelectric Sensors
- Industrial Vision
- Ultrasonic Sensors
- Rotary Encoders
- Positioning Systems
- Inclination and Acceleration Sensors
- AS-Interface
- Identification Systems
- Logic Control Units